

Undergraduate Internship Report



INTERNSHIP REPORT

ON

SUBSTATION EQUIPMENT PRODUCTION AT ENERGOPAC ENGINEERING LTD.

By

MD. SHAMIM KHAN (2006-2-80-023)

Submitted to the
Department of Electrical and Electronic Engineering
Faculty of Sciences and Engineering
East West University

In partial fulfillment of the requirements for the degree of Bachelor of
Science in Electrical and Electronic Engineering
(B.Sc. in EEE)

[Summer, 2011]



Approved By

 03.10.2011

Academic Advisor

[S. M. Shahriar Rashi]

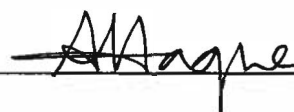
 03.10.2011

Department Chairperson

[Dr. Anisul Haque]

Approval Letter



CORP. OFFICE :
JIBAN BIMA TOWER, 9TH & 11TH FL.
10 DILKUSHA COMM. AREA
DHAKA-1000, BANGLADESH
PHONE: 9561883
FAK : 880-2-9563728
E-mail : info@energypac-bd.com
rabul@energypac-bd.com

EELF/Admin/EWU/TR/2011-07(01)
Date: 20th July 2011

TRAINING CERTIFICATE

This is to certify that **Md. Shamim Khan**, Bearing Roll No. **2006-2-80-023**, a Student of Electrical and Electronic Engineering Department of East West University of Bangladesh. He was attended an Industrial Practice, which was programmed from 2nd May'2011 to 16th May'2011 at Energypac Engineering Ltd. Factory, Baruipara, Savar, Dhaka, Bangladesh. During his Industrial attachment he has taken some practical experiences about Power Transformer, Distribution Transformer, Instrument Transformer (Both CT & PT), Impulse, Isolator, Switchgear Items (LT, HT & PFI) Breaker, Machine Shop, Fabrication, CNC, Powder Coating and Liquid Paint.

Nothing has been recorded against his character and conduct during his attachment.

I wish him every success in life.

শফিক উদ্দিন
27/07/2011

Engr. Md. Shafique Uddin Khan
AGM (Admin & Utility),
Energypac Engineering Ltd.



First ISO 9001:2008 & 14001:2004 Power Engineering Company in Bangladesh

E:\Documents\Faruk\Training\EWU\West.doc

ENERGYPAC ENGINEERING LTD.

WORKS : BARUIPARA SAVAR, DHAKA
CTG. OFF : HOUSE # 6, LANE # 1, ROAD # 3, BLOCK K, HALISHAHAR HOUSING ESTATE, CHITTAGONG, TEL: 715473, 723557, R11697
KHL. OFF : 84, KHAN JAHAN ALI ROAD, KHULNA, TEL: 041 2832045, TEL FAX: 722546
RAJ. OFF : 373, MOUTRI LANE, GHORAMARA, RAJSHAHI, CELL: 0171-1810991

See us at : www.energypac-bd.com

Acknowledgement



First of all I would like to thank Engr. Rabiul Alam, Director & CEO, Energypac Engineering Ltd. (EEL), Engr. Md. Azizur Rahman Molla , AGM & Head of HR & Admin, EEL, Mr. Munirul Huda, my superintendent Engineer and Sr. Engineer, EMR & QC, EEL for allowing us to do the internship and work in their team.

I would also like to thank my advisor S. M. Shahriar Rashid, Research Lecturer, Department of Electrical & Electronic Engineering, East West University (EWU), Bangladesh. I would also like to mention the name of Dr. Anisul Haque, Chairperson & Professor of the Department of Electrical & Electronic Engineering, EWU for being so kind during the period of our internship. I am also grateful to all of our teachers and friends for their cooperation and encouragement throughout my whole academic life in EWU.

The job impression at Energypac was excellent and I received amazing support from all concerned officials. I would specially like to thank all my supervisors, who had given their precious time in Energypac Engineering Ltd. during my internship and also helped me to understand many related matters. I would like to thank all the respected officers and employees of Energypac Engineering Ltd. for their support.

I wish to express my gratitude to my parents for their support throughout my whole life and having faith on me.

At last but not at the least I would like to thank the almighty Allah for giving me the chance to complete my internship properly at Energypac Engineering Ltd.

Executive Summary

Electricity is considered obligatory all over the place since its invention. Modern life is impossible without proper supply of electricity. Even, it is called the prime mover of a state. Bangladesh is a developing country and it is facing power crisis. Only 48 % of the total population has a kind of access to electricity. To ensure the electricity supply to all, the government has taken various short term and long term project. Energypac Engineering Ltd, one of the best power engineering companies not only in Bangladesh but also in South-Asia is contributing to the country by serving different types of products & services related to substation. Being a local company it also helps our country to save foreign currency.

The report is about my industrial attachment at the factory of 'Energypac Engineering Ltd.' situated at Baruipara, Savar, Dhaka. The factory is divided into different sections but all sections work mutually. Starting from the transformer core cutting, core making, coil winding, core coil assembling, in process testing, and tanking, all the process related to transformer manufacturing is done under the transformer section at the factory. The high voltage lab is used for different routine and type test of transformer. Both the indoor and outdoor type current and potential transformer is manufactured at the instrumental transformer section. Different switchgear components like LT switchgear, HT switchgear, PFI panel, VCB, LBS, input & output control panel are assembled at switchgear section of the factory. Different types of isolator and switches are also manufactured at the isolator and breaker section. The fabrication section helps to fabricate different parts of different products. Besides, the factory has its own paint and coating section for liquid painting, powder coating, and nickel coating over different products. The factory has its update CNC section and machine shops too. All these sections and facilities at the factory of Energypac Engineering Ltd help Energypac to achieve their products a new standard.

My industrial attachment at 'Energypac Engineering Ltd' was really a great opportunity for me to compare my theoretical knowledge with practical experience. With the help of the honorable officials and my hard work I have successfully completed my internship. I am really grateful to almighty Allah.

Undergraduate Internship Report

Detail of Internship Work

Date	Session Work	Supervisor	Session	Duration
02.05.11	A brief about “Energypac Engineering Ltd.” Get familiar with the factory. Different Parts & steps of construction of a Power Transformer. Automatic Core Cutting & setting, Stack arrangement. Get familiar with LT, HT, and Taping coil. Top yoke out, Coil positioning, Top yoke fill. Vacuum drying plant. Magnetic balance test.	Engr. Asaduzzaman	08.00-17.00	08 hours
03.05.11	A brief about process of making a power transformer, In process & routine test of Power Transformer. Get familiar with Nameplate, Bushing, Tap changer, Marshaling Box, Buckholtz relay, Surge relay, Radiator, Oil filling, Tanking etc. Heat run test, Megger test, Continuity test, Ratio test, Magnetizing current test.	Engr. Asaduzzaman Engr. Asif Islam	08.00-17.00	08 hours
04.05.11	A brief about process of making Distribution Transformer & Difference between Power and Distribution Transformer. Auto & Manual Core Cutting & Setting. Get familiar with LT, HT, and Taping coil. Top yoke out, Coil positioning, Top yoke fill. In process tests, routine tests, delivery tests of Distribution Transformer.	Engr. Moniruzzaman	08.00-17.00	08 hours
05.05.11	Familiar with Coil Winding, Construction of Coil for both power and distribution transformer. In process test of core winding, Oil test, Ratio test of distribution transformer.	Engr. Masum Engr. Moniruzzaman	08.00-17.00	08 hours
07.05.11	Megger test, No Load Test, Full Load Test, High Voltage Test, Winding Resistance Test, Ratio Test of 3 Phase Power Transformer.	Engr. Asim Kumar Bhakta	08.00-17.00	08 hours
08.05.11	A brief about Switchgear Section. LT Switchgear, ACB, LBS. Distribution Box	Engr. Sayed Muztaba Ali Engr. Mahbul Alam	08.00-17.00	08 hours

Undergraduate Internship Report

09.05.11	Input, Output, Relay, Bus coupler, AC distribution, Metering, and Control panel of Transformer, Construction of PFI, In process test.	Engr. Mahbul Alam	08.00-17.00	08 hours
10.05.11	Marshaling Box, Remote tap changer cubicle, Indoor & Outdoor VCB, Endurance test, Megger test, Contact resistance test, High voltage test, Analyzer test for VCB.	Engr. Mahbul Alam Engr. Tauhid	08.00-17.00	08 hours
11.05.11	A brief about Dry Type CT & PT, Oil Type CT & PT, and Construction of Dry type CT & Oil type PT. In process test	Engr. Mozaharul Islam Engr. Faisal	08.00-17.00	08 hours
12.05.11	Construction of Dry type CT & PT , Oil type CT & PT, High voltage, DVDF, PD tests	Engr. Mozaharul Islam Engr. Faisal	08.00-17.00	08 hours
14.05.11	A brief about Isolator & Switch, Construction of Isolator, some tests.	Engr. Ataul Goni	08.00-17.00	08 hours
15.05.11	No Load Test, Full Load Test, High Voltage Test, Winding Resistance Test, Turns Ratio Test of Single Phase Power Transformer	Engr. Asim Kumar Bhakta	08.00-17.00	08 hours
16.05.11	Fabrication, Machine Shop Powder Coating, CNC	Engr. Azimussan Abbasi Engr. M.A. Wazed Mr. N.M. Habibullah	08.00-13.00	05 hours

Total duration: 101 hours.

N.B: 13.00 - 14.00 is lunch time. The duration is calculated excluding lunch break.



TABLE OF CONTENTS

Contents	Page No
APPROVAL LETTER	2
ACKNOWLEDGEMENT	3
EXECUTIVE SUMMARY	4
DETAIL OF INTERNSHIP WORK.....	5
TABLE OF CONTENTS.....	7
CHAPTER 01	16
1. INTRODUCTION:	16
1.1. COMPANY OVERVIEW.....	16
1.1.1. <i>Vision, mission and strategy of company</i>	17
1.1.2. <i>Board of Directors</i>	17
1.1.3. <i>Quality policy</i>	18
1.1.4. <i>Environment, health & safety policy</i>	18
1.2. OBJECTIVE OF THE INTERNSHIP.....	18
1.3. SCOPE AND METHODOLOGY	19
CHAPTER 02	20
2. TRANSFORMER SECTION	20
2.1. INTRODUCTION TO TRANSFORMER	20
2.2. TYPES OF TRANSFORMER:.....	21
2.3. TRANSFORMER RATING:.....	21
2.4. IMPORTANT RAW MATERIALS OF TRANSFORMER:.....	21
2.5. MAIN PARTS OF A TRANSFORMER	22
2.6. PRODUCTION PROCESS FLOW CHART OF A DISTRIBUTION TRANSFORMER	23
2.7. TWO IMPORTANT PROCESSES RELATED WITH TRANSFORMER MANUFACTURING.....	24
2.7.1. <i>Core cutting</i>	24
2.7.2. <i>Coil winding</i>	25
2.8. BRIEF DESCRIPTION ABOUT TRANSFORMER MANUFACTURING PROCESS	27
2.8.1. <i>Channel setting</i>	28
2.8.2. <i>Core assembling</i>	28
2.8.3. <i>Vacuum drying plant</i>	30

Undergraduate Internship Report

2.8.4.	<i>Top yoke out</i>	30
2.8.5.	<i>Core coil assembly</i>	31
2.8.6.	<i>Top yoke fill</i>	33
2.8.7.	<i>Tap changer setting</i>	33
2.8.8.	<i>Tanking</i>	34
2.8.9.	<i>Vacuum drying plant</i>	34
2.8.10.	<i>Oil filling</i>	34
2.9.	TAP CHANGER	35
2.9.1.	<i>Types of tap changer</i>	35
2.9.2.	<i>On load tap changer</i>	35
2.9.3.	<i>On load tap changer vital equipment</i>	36
2.9.4.	<i>Tap changer working example</i>	36
2.9.5.	<i>Nameplate of on load tap changer driving box</i>	38
2.9.6.	<i>Control selection</i>	38
2.9.7.	<i>Indicators</i>	39
2.10.	PRODUCTION PROCESS FLOW CHART OF POWER TRANSFORMER	39
2.11.	NAMEPLATE OF A POWER TRANSFORMER	41
2.12.	CHECKLIST FOR ANY NORMAL TRANSFORMER	44
2.13.	SOME IMPORTANT PARTS OF TRANSFORMER	45
2.13.1.	<i>Radiator & Radiator fan</i>	45
2.13.2.	<i>Conservator</i>	46
2.13.3.	<i>Protecting components</i>	46
2.13.4.	<i>Buckholtz relay</i>	46
2.13.5.	<i>Silica gel breather</i>	47
2.13.6.	<i>HT & LT bushes</i>	47
2.13.7.	<i>Marshaling box</i>	48
2.13.8.	<i>Air vent</i>	49
2.13.9.	<i>Drain valve</i>	49
CHAPTER 03	50
3.	TEST OF TRANSFORMERS	50
3.1.	IN PROCESS TEST OF TRANSFORMERS	50
3.1.1.	<i>Continuity test</i>	51
3.1.2.	<i>Ratio test</i>	51
3.1.3.	<i>Megger (insulation resistance test)</i>	52
3.1.4.	<i>Magnetic balance test</i>	53
3.2.	ROUTINE TEST OF TRANSFORMER	54
3.2.1.	<i>Measurement of winding resistance</i>	54
3.2.2.	<i>No load test</i>	55
3.2.3.	<i>Vector group test</i>	56
3.2.4.	<i>Power frequency withstand test</i>	58
3.2.5.	<i>Ratio test</i>	59
3.2.6.	<i>Measurement of di-electric strength of transformer oil</i>	59
3.3.	TYPE TEST	60
3.4.	HIGH VOLTAGE LAB COMPONENTS	61

Undergraduate Internship Report

CHAPTER 04	64
4. SWITCHGEAR	64
4.1. INTRODUCTION TO SWITCHGEAR	64
4.2. TYPES OF SWITCH GEAR.....	64
4.2.1. <i>HT switch gear</i>	65
4.2.2. <i>LT switch gear</i>	65
4.2.3. <i>Control panel</i>	65
4.2.4. <i>Others products</i>	66
4.3. VACUUM CIRCUIT BREAKER (VCB).....	66
4.3.1. <i>VCB types</i>	66
4.3.2. <i>VCB items area specification</i>	68
4.3.3. <i>Process flow chart of HT switch gear (VCB)</i>	69
4.4. VCB TEST.....	70
4.4.1. <i>Endurance test</i>	70
4.4.2. <i>Megger Test</i>	70
4.4.3. <i>High Voltage Test</i>	70
4.4.4. <i>Analyzer test</i>	71
4.4.5. <i>Contact Resistance Test</i>	71
4.5. LOAD BREAKER SWITCH.....	72
4.5.1. <i>Main parts of LBS</i>	72
4.5.2. <i>Process flow chart of HT Load Break Switch</i>	73
4.6. LT SWITCHGEAR.....	74
4.6.1. <i>LT switchgear vital components</i>	74
4.6.2. <i>Process flow chart of LT switch gear</i>	75
4.7. POWER FACTOR IMPROVEMENT (PFI) PLANT	76
4.7.1. <i>PFI panel vital components</i>	76
CHAPTER 05	77
5. INSTRUMENT TRANSFORMER	77
5.1. INTRODUCTION TO INSTRUMENT TRANSFORMER	77
5.2. TYPES OF INSTRUMENT TRANSFORMER	77
5.2.1. <i>Current Transformer</i>	78
5.2.2. <i>Potential Transformer</i>	78
5.3. APPLICATION OF INSTRUMENT TRANSFORMER.....	78
5.4. TYPES OF PRODUCTS.....	78
5.5. INDOOR (DRY) TYPE CT / PT	79
5.5.1. <i>Chemical used for cast resin CT / PT</i>	79
5.5.2. <i>Manufacturing process flow chart of indoor type CT / PT</i>	80
5.5.3. <i>Process description</i>	81
5.6. OIL TYPE PT	83
5.6.1. <i>Main parts</i>	83
5.6.2. <i>Process of manufacturing</i>	83
5.7. OILTYPE CT.....	86
5.7.1. <i>Process of manufacturing</i>	86

Undergraduate Internship Report

5.8. RING TYPE CT	87
5.9. NAMEPLATE OF A CT	88
5.10. TESTING	89
5.10.1. Routine tests	89
5.10.2. Special Test	89
5.10.3. Types test	89
CHAPTER 6.....	91
6. ISOLATOR AND SWITCH	91
6.1. INTRODUCTION TO ISOLATOR AND SWITCH	91
6.2. TYPES OF ISOLATOR.....	91
6.2.1. Main parts of an ideal Isolator	93
6.2.2. Raw Materials for Isolator.....	93
6.2.3. Operation Performed.....	93
6.2.4. Machine used	94
6.2.5. Process flow chart of 33 kv fused isolator,	
6.2.6. Nameplate of an Isolator.....	95
6.2.7. Tests for Isolator	95
6.3. SWITCHES	96
CHAPTER 7.....	97
7. FABRICATION SECTION	97
7.1. INTRODUCTION TO FABRICATION SECTION	97
7.2. TYPES OF PRODUCT	97
7.3. OPERATIONS PERFORMED.....	97
7.4. MACHINE USED	98
7.5. OPERATIONS OF MACHINES	99
7.5.1. Hydraulic shear machine	99
7.5.2. Hydraulic Bending Machine	99
7.5.3. Power Bending Machine	99
7.5.4. Forming Machine.....	99
7.5.5. Power Press Machine	100
7.5.6. Seam welding Machine	100
7.5.7. Knurling Machine	100
7.5.8. Electric Arc Welding Machine.....	100
7.5.9. MIG Welding Machine.....	101
7.5.10. Radial Column Drill Machine	101
7.5.11. N.C Hydraulic Press Break Machine	101
7.5.12. C Hydraulic Shear Machine	101
7.5.13. Gas Cutting	
7.5.14. Plasma Cutting Machine	
7.6. TESTING.....	103
7.6.1. Radiator Testing:	103
7.6.2. Tank Testing:.....	103

Undergraduate Internship Report

CHAPTER 8.....	104
8. POWDER COATING.....	104
8.1. INTRODUCTION TO POWDER COATING SECTION	104
8.2. POWDER COATING METHOD.....	104
8.3. METAL & POWDER	105
8.4. POWDER TYPES.....	105
8.5. SURFACE TYPES.....	105
8.6. MANUFACTURING STEPS	105
8.6.1. <i>First Step: Preparing elements</i>	106
8.6.2. <i>Second Step: Powder coating</i>	107
8.7. MERITS.....	107
CHAPTER 9.....	108
9. LIQUID PAINT.....	108
9.1. INTRODUCTION TO LIQUID PAINT	108
9.2. PAINT TYPES.....	108
9.3. LIQUID PAINTING PROCEDURE	108
9.4. NORMAL PAINT	109
9.4.1. <i>Primer Paint</i>	109
9.4.2. <i>Final Paint</i>	110
9.4.3. <i>Paint duration</i>	110
9.5. EPOXY PAINT.....	110
9.5.1. <i>Primer paint</i>	110
9.5.2. <i>Final Paint</i>	111
9.5.3. <i>Paint duration</i>	111
9.6. MERITS.....	111
CHAPTER 10	112
10. NICKEL COATING SECTION.....	112
10.1. INTRODUCTION TO NICKEL COATING SECTION.....	112
10.2. OPERATION PERFORMED	112
10.3. NICKEL COATING PROCEDURE	113
10.4. MERITS.....	113
CHAPTER 11	
11. CNC SECTION	114
11.1. INTRODUCTION TO CNC SECTION.....	114
11.2. CNC PROGRAM PROCESS DIAGRAM.....	114
11.3. USED SOFTWARE.....	115
11.4. PROGRAM LOAD PROCEDURE.....	115

Undergraduate Internship Report

11.5.	CONTROL SYSTEM.....	115
11.5.1.	<i>Air System</i>	116
11.5.2.	<i>Hydraulic system</i>	116
11.6.	SECTION ARRANGEMENT.....	116
11.7.	REQUIRED CLEARANCE FOR VARIOUS METAL SHEETS.....	116
11.8.	MINIMUM HOLE DIAMETER.....	116
11.9.	PUNCHING CAPACITY.....	117
CHAPTER 12		118
12.	MACHINE SHOP.....	118
12.1.	INTRODUCTION TO MACHINE SHOP.....	118
12.2.	TYPES OF MACHINE USED.....	118
12.3.	OPERATION OFFERED.....	119
12.4.	TYPES OF JOB PROCESSED HERE.....	119
12.4.1.	<i>CT-PT Tank</i>	119
12.4.2.	<i>CT Finishing Task</i>	120
12.4.3.	<i>PT Finishing Task</i>	120
12.4.4.	<i>Casting CT-PT</i>	120
12.4.5.	<i>Power & Distribution Transformer</i>	120
12.4.6.	<i>Switch Gear</i>	121
12.4.7.	<i>VCB</i>	121
CHAPTER 13		122
13.	SAFETY MANAGEMENT.....	122
13.1.	SAFETY EQUIPMENTS PROVIDED.....	122
13.2.	MATERIAL HANDLING EQUIPMENTS.....	122
13.3.	SAFETY EQUIPMENTS FOR EFFECTIVE FIRE SYSTEM.....	123
13.4.	SOME FINDINGS ABOUT SAFETY.....	123
CHAPTER 14		125
14.	CONCLUSION.....	125
14.1.	COMMENTS ABOUT THE FACTORY.....	125
14.2.	CONCLUSION.....	125

Undergraduate Internship Report

LIST OF FIGURES.....	Page
Figure 2-1: Production process flow chart of a distribution transformer.....	23
Figure 2-2: Geometrical view of manually core cutting	24
Figure 2-3: Geometrical view of auto core cutting.....	25
Figure 2-4: A snapshot of a coil winding machine	25
Figure 2-5: An example of spiral coil	26
Figure 2-6: An example of disc coil.....	26
Figure 2-7: A snapshot of channel setting.....	28
Figure 2-8: Geometrical view of core assembly	29
Figure 2-9: Core setting at beginning.....	30
Figure 2-10: Core with channel placed vertically	31
Figure 2-11: A screenshot after removing Top yoke	31
Figure 2-12: Core coil assembly	32
Figure 2-13: Core assembly completed, waiting for top yoke fill	32
Figure 2-14: Transformer with off load tap changer.....	33
Figure 2-15: Transformer ready to dispatch.....	34
Figure 2-16: On load Tap Changer working circuit diagram.....	35
Figure 2-17: A 75 MVA Power Transformer (with on load tap changer)	37
Figure 2-18: On load tap changer driving box a) outer view b) Inner view	37
Figure 2-19: Nameplate of a Driving Box of Tap Changer	38
Figure 2-20: An example of control switch indicator of a tap changer	38
Figure 2-21: Production process flow chart of power transformer	40
Figure 2-22: Radiator and Radiator Fan of a transformer.....	45
Figure 2-23: Conservator Tank of a transformer	46
Figure 2-24: An example of Buckholtz Relay	47
Figure 2-25: example of Silica Gel Breather	47
Figure 2-26: Bushing of a transformer	48
Figure 2-27: An example of Marshaling Box assembled in Energypac	48
Figure 2-28: OTI and WTI used in marshaling box.....	48
Figure 2-29: An example of an air vent	49
Figure 3-1: Multimeter used for continuity test.	51
Figure 3-2: ATRM - 200, Automatic Transformer Ratio Meter.....	51
Figure 3-3: An example of Megohm meter (Megger) used in Energypac	52
Figure 3-4: Connection diagram for winding resistance measurement.....	54
Figure 3-5: Connection diagram of no load test.....	55
Figure 3-6: A screenshot of No load test Equipment panel	55

Undergraduate Internship Report

Figure 3-7: Circuit diagram of YdI connection	57
Figure 3-8: Connection diagram for Power Frequency Withstand Test	58
Figure 3-9: Connection diagram for ratio test.....	59
Figure 3-11: Oil Tester Circuit.....	59
Figure 3-12: An example of Oil Tester used at Energypac.....	60
Figure 3-13: High voltage test components	61
Figure 3-14: Impulse voltage divider.....	61
Figure 3-15: Multilevel Chopping Gap.....	62
Figure 3-16: Impulse Voltage Generator	63
Figure 4-1: Example of Indoor type VCB and Outdoor type VCB	66
Figure 4-2: A screenshot of Outdoor type VCB driving box; Upper side	67
Figure 4-3: Indoor type VCB driving Box front view; internal view; VCB Interrupter. 67	
Figure 4-4: Manufacturing process of a vacuum circuit breaker	69
Figure 4-5: Internal and external view of LBS	72
Figure 4-6: Process flow chart of HT load break switch	73
Figure 4-7: A screenshot of LT switchgear manufactured at Energypac.....	74
Figure 4-8: Process flow chart of LT switchgear.....	75
Figure 4-9: PFI panel with Harmonic Filter Reactor; Capacitor bank; Front view	76
Figure 5-1: Indoor type resin cast CT & PT manufactured at Energypac.....	79
Figure 5-2: Manufacturing process flow chart of indoor type CT or PT	80
Figure 5-3: Core coil assembly for indoor type CT	81
Figure 5-4: Preparing for molding for indoor type CT	82
Figure 5-5: Pouring and mixing chamber for indoor type CT / PT	82
Figure 5-6: An example of Core used for oil type PT.....	83
Figure 5-7: An example of HT coil of oil type PT.....	84
Figure 5-8: Examples of oil type PT after core coil assembly.....	84
Figure 5-9: An example of PT bottom tank for oil type PT.....	85
Figure 5-10: An example of oil type PT	85
Figure 5-11: A screenshot of Core used for oil type CT / PT	86
Figure 5-12: Protection coil; metering coil.....	86
Figure 5-13: CT at different stages	87
Figure 5-14: Geometric view of a ring type CT.....	87
Figure 6-1: Single break isolator ; Double break isolator	92
Figure 6-2: Central break isolator and its driving box	92
Figure 6-3: Process flow chart of an isolator	94

Undergraduate Internship Report

Figure 6-4: A snapshot of switches displayed at Energypac.....	96
Figure 8-1: A snapshot of Powder Coating Section at EEL.....	104
Figure 8-2: An example of powder spray gun	105
Figure 8-3: First step of working procedure of preparing elements for powder coating.....	106
Figure 8-4: A snapshot of powder coating booth at EEL.....	107
Figure 9-1: Liquid painting working procedure.....	109
Figure 9-2: Paint duration with the steps name for normal liquid paint	110
Figure 9-3: Paint duration with the steps name for epoxy liquid paint.....	111
Figure 10-1: Nickel coating procedure	113
Figure 11-1: Program process diagram for CNC machine.....	114
Figure 11-2: Program load procedure for CNC procedure	115

LIST OF TABLES

Page

Table 2-1: An example of Coil Winding Order Sheet	27
Table 2-2: An example of Order sheet provided for Core assembling	28
Table 2-3: An example of Tap changer working	36
Table 3-1: An example of Ratio Test result sheet.....	52
Table 3-2: An example of Magnetic Balance Test result sheet	53
Table 3-3: An example of No Load Test result sheet	55
Table 4-1: VCB items area specification	68
Table 10-1: Operation performed under nickle coating section.....	112
Table 12-1: Operation offered at machine shop.....	119



CHAPTER 01

INTRODUCTION

Electricity is considered as the prime mover of a state. A Modern country without electricity is unimaginable. Bangladesh is a developing country and is also marching towards modernization. But, the country is facing power crisis, which is the main constraint for development. Only 48 % of the total population has a kind of access to electricity. Energypac Engineering Ltd, one of the best power engineering companies not only in Bangladesh but also in South-Asia is contributing to the country by serving different types of products & services required for substation. Being a local company it also helps our country to save foreign exchange. In the sector of power engineering in Bangladesh, Energypac has become the synonym of destiny, reliability, loyalty, goodwill, and fame to their customer. With enhanced production facility, eminence products, persistent research, proficient services, now-a-days, Energypac is one of the leading companies in Bangladesh. With a few manpower and limited service, Energypac started their function as a small 'private limited business enterprise' in 1982. But, at present it is powered by 1200 skilled manpower of which 150 are graduated engineers.

1.1. Company Overview

Energypac Engineering Ltd, specializes in Power, Distribution & Instrumental Transformer production, and related equipment required for substation. Energypac never delay in delivery and after sales service is none to compare, from setup, testing, job training, components design, Energypac able to keep up with customer's demands. Because of strong research ability, professionalism and diligent marketing staff, Energypac as a team is able to extend the business not only in local market but also promote to international markets in a short period of time. From the starting of their journey until now, Energypac extend its market to India, Yemen, Ghana, Sudan, Uganda, Nigeria, Saudi Arabia, and United Kingdom. With a strong RnD team, Energypac is able to develop production with increase efficiency and reduce production cost, create better and environmentally compatible technologies.

1.1.1. Vision, mission and strategy of company

Vision

Energypac want to be the supreme business partner of their clients.

Mission

Energypac will offer overall power solutions to boost the business of their customers by introducing environment friendly superior technology which will be beneficial for both the consumers and the country.

Strategy

The strategic aim is to strengthen the leading position we enjoy in our markets, and to ensure continued growth. We rely on our capability to integrate and deliver solutions from our broad equipment and service portfolio which meet the specific needs of our customer segments globally. Our priority is to offer the best efficiency, reliability and value available.

1.1.2. Board of Directors

Board of Directors



Enamul Haque Chowdhury
Managing Director
Energypac Engineering Ltd.



Engr. Rabiul Alam
Director & CEO
Energypac Engineering Ltd.



Humayun Rashid
Executive Director
Energypac Engineering Ltd.

Undergraduate Internship Report

1.1.3. Quality policy

Energypac Engineering Ltd is committed to provide Quality Products and Services by:

- Ensuring continual improvement in all fields of activities.
- Ensuring total customer satisfaction for all time.
- Adopting updated and latest technology in the field.
- Ensuring best utilization of human resources.
- Adhering to applicable legal & regulatory requirements.

1.1.4. Environment, health & safety policy

Energypac Engineering Ltd is committed to protect the natural environment and provide clean, safe and healthy facilities and work practices. This commitment includes:

- Compliance with Environmental Legal Requirements.
- Health Protection, Health Promotion, Risk Reduction, Prevention and Resource Management.
- Effective Communication Mechanism.
- Concept of Continuous Improvement.

1.2. Objective of the Internship

The key purposes of this report are to accomplish the partial requirement of 'B.Sc. in Electrical & Electronic Engineering' program and acquire some realistic knowledge for my future benefit.

The additional objectives are:

- Collecting knowledge regarding substation & substation equipments.
- Accumulating knowledge about transformer, switchgear, isolator and breaker.
- Observing the manufacturing process of transformer, switchgear isolator and breaker.
- Keeping an eye on the design technique & method.
- Being acquainted with the duty and responsibilities of an Engineer.
- Realizing the organizational management system.
- Working under factory environment to earn some realistic knowledge.

Undergraduate Internship Report

1.3. Scope and Methodology

Energypac Engineering Ltd is one of the best power engineering companies in South Asia. So there is a great scope of learning the manufacturing process of different power equipments, different department management system. This gives a general idea about the environment of a company.

This report has been prepared mainly on the basis of the information collected through my internship period at Energypac Engineering Ltd. That information was not adequate for preparing the report so I have to take the help of the official website of Energypac Engineering Ltd. and some other website also.

Energypac Engineering Ltd, one of the best power engineering companies in Bangladesh, earns the faith of the customer by their uninterrupted services of different substation products. In this chapter the company overview with the mission and vision of Energypac Engineering Ltd is discussed. The objective of this report as well as the process and method of acquiring data for writing the report is also discussed in this chapter.

CHAPTER 02

TRANSFORMER SECTION

It was the first day of my internship at 'Energypac Engineering Ltd'. I was sent to Engr. Asaduzzaman, Section-in-Charge, Transformer Section. He gave me a brief idea about Energypac Engineering Ltd, their business policy, quality policy and some information about power transformer. Then I visited the power transformer section. For next four days (May 02, 2011 – May 05, 2011), I worked at transformer section under the supervision of Engr. Asaduzzaman, Engr. Asif Islam, Engr. Masum & Engr. Moniruzzaman. At the beginning of every single day, I was given some ideas about their working procedure and after that I visited the sections. At the end of every single day, I reported to my supervisor regarding my observation & understanding throughout the whole day. The chapter will give a complete concept about the built-up method of power and distribution transformer. Starting from the method of cutting and setting of transformer core, winding HT & LT coil, core-coil assembling, tap changer setting, tanking, safety equipment setting and finally oil filling, this chapter will incorporate every single method followed at the Energypac factory for the manufacturing of a complete transformer .

2.1 Introduction to Transformer

Transformer is a stationary electrical device whose main function is to transmit the input voltage to output voltage as step down or step up from one circuit to another. According to the client demand both step up and step down transformer are manufactured at Energypac. Most of the raw materials of the transformer are brought from outside. Then all parts of the transformer are processed and assembled and finally delivered to the client.

2.2. Types of Transformer:

Energypac manufacture different type of transformer based on the customer demand. Basically two types of transformer are manufactured in the transformer section of Energypac.

- Distribution transformer
- Power transformer

2.3. Transformer Rating:

The transformers vary in their rating depending on the demand of the customer and their types. Energypac manufactures the transformers with:

- Power rating (50 KVA – 75 MVA)
- Voltage rating (0.415 KV – 230 KV)

2.4. Important Raw Materials of Transformer:

To manufacture a transformer various raw materials is required. Among them some are most important and widely used. The name of some of the materials is given below.

- Silicon steel
- Mild steel sheet
- Copper
- Transformer oil
- Stainless steel
- Brass
- Aluminium
- Silica gel
- Rubber

2.5. Main Parts of a Transformer

A transformer consists of different parts. All parts are equally important for the proper working of a transformer. Therefore, some parts play more important role for the transformer. The name of some vital parts of the transformer is given below.

- Core
- LT coil
- HT coil
- Transformer oil
- Transformer tank
- Bushing
- Tapping
- Radiator
- Breather box
- Conservator tank



2.6. Production Process Flow Chart of a Distribution Transformer

The production process of a distribution transformer is divided into some phases and some sub phases, which are expressed as a form of work process flow chart in below.

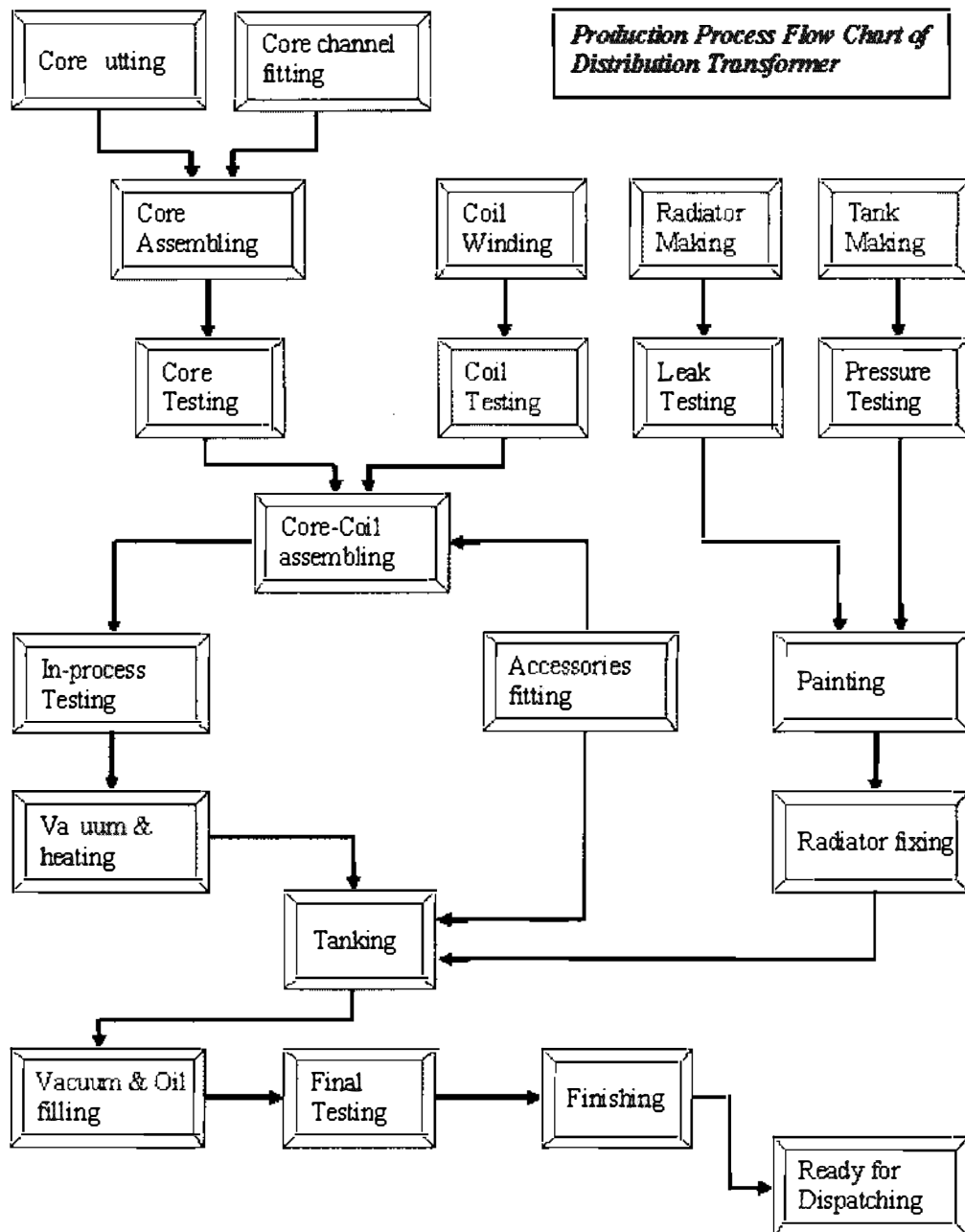

Figure -: Production process flow chart of a distribution transformer

2.7. Two Important Processes Related With Transformer Manufacturing

Before the main body of a transformer is started to build some pre work is needed. Among them two important process are Core cutting and Coil winding. This work is done under two different sub section Core cutting section and Coil winding section.

2.7.1. Core cutting

Core is one of the important parts of transformers. So, Core cutting is truly important phase for transformer manufacturing. Core cutting needs to be done before all process of transformer manufacturing; as core is needed for core assembling, which is basically the first process of transformer manufacturing.

Two process of core cutting is followed at Energypac. One is manual core cutting and another one is automatic core cutting.

▣ Manual Core Cutting:

Using a machine, driven with hand and foot the core is cut. Mainly this type of core is used for small distribution transformer ranges from 100 kV to 1250 kV. The main characteristic of the core cut manually is their side shape (figure 2-1).

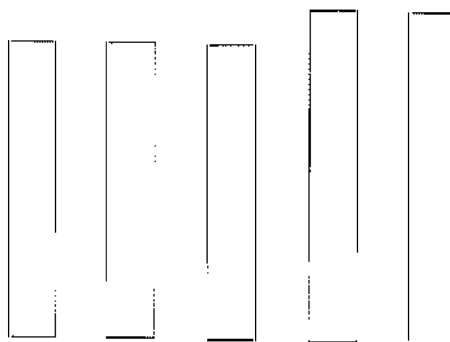

Figure -: Geometrical view of manually core cutting

Undergraduate Internship Report

Automatic Core Cutting:

Using an auto machine called “Auto Core Sharing Machine” from “Micro Tool & Machine Ltd. Winnipeg, Canada” the core is cut. Mainly this type of core is used for Power transformer & Distribution transformer more than 1250 kV. The core cut by auto core cutting machine differs with manual core cutting in their side shape (figure 2-2).

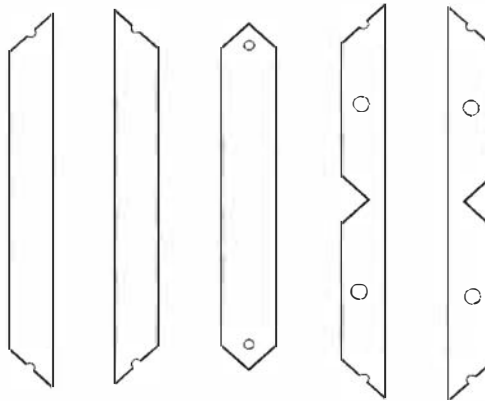

Figure -: Geometrical view of auto core cutting

2.7.2. Coil winding

Coil is one of the most important parts of a transformer. Coil winding is also very important phase for transformer manufacturing, which is done by a coil winding machine (figure 2-3). Coil is needed at the time of core coil assembling of a transformer. Two type coils are used in the factory of Energypac. One is Spiral coil and another one is Disk coil.

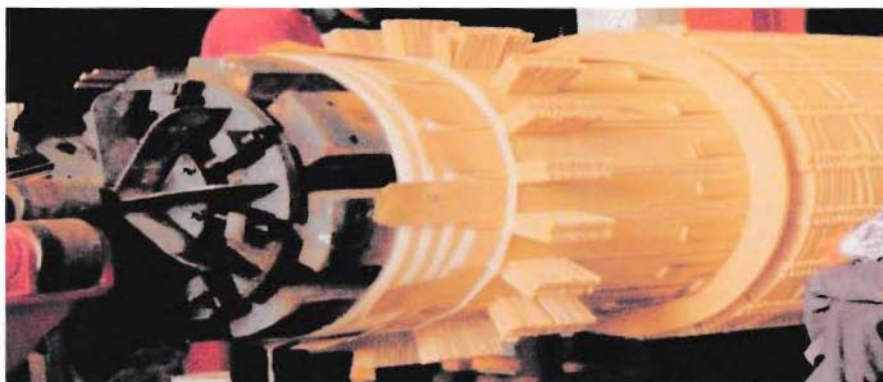

Figure -: A snapshot of a coil winding machine

Undergraduate Internship Report

Coil winding is done by some skilled workers able to run the coil winding machine. An order sheet (table 2-1) is provided from the RnD of Energypac to the workers of coil winding section. Then the workers complete the winding according to the order sheet. After completing the winding, engineers check the coil and remark on the tag connected to the coil.

Spiral coil:

Spiral coil (figure 2-4) is used for both HT and LT coil of distribution transformer and power transformer depending on customer choice. The ratings for spiral coil are below 2 MV.



Figure -: An example of spiral coil

Disc coil:

Disc coil (figure 2-5) is used for HT and LT coil of power transformer. The shape of this coil is round like a disc. So it is called as a disc coil.



Figure -: An example of disc coil

Table -: An example of Coil Winding Order Sheet

Name of the Client			
HV coil			
MVA :		1.5 ;	Ratio 11 / 0.415 KV
Parameter	Designed Value	Checked Value	Remark
Forma, Metal Jacket, Setting & Dimension	N / A	Checked	
Conductor Size (Bare)	$8 \times 1.8 / 6 \times 2.4$	$8 \times 1.8 / 6 \times 2.4$	
Paper Insulation of Conductor	0.4 / 0.5	0.4 / 0.5	
Winding Type	C . Disc	C . Disc	
Total Turns	847 T	847 T	
K-Block Size	38 – 45	38 - 45	
In Dia	322 mm	322 mm	
Out Dia	394 mm	394 mm	
Radial Depth	36 mm	36 mm	
Axial Length	625 mm	660 mm	
Transposition Checking	N / A		
Terrninal Marking	N / A		
Cooling Ducts	OK	OK	
No of Blocks Per Cycle	12	12	

2.8. Brief description about transformer manufacturing process

The transformer manufacturing is actually divided into different phases. The whole work is done under different sections under different hoods at Energypac. Here only those processes are going to be described which are the main processes of transformer manufacturing.

Undergraduate Internship Report

2.8.1. Channel setting

An order sheet is provided from RnD (Table: 2-2). According to the instruction 4 channels is set, 2 in top and 2 in bottom. At first one of the top and one of the bottoms is set horizontally. The difference between two channels will be same as window height. The distance between the opposite corner has to be 100% same.



Figure -: A snapshot of channel setting

At first 3 flitch plates is set at 3 places, for 3 phase transformer. Then 3 press boards are placed on 3 flitch plates and on two other sides on the channel.

2.8.2. Core assembling

According to the instruction of order sheet (Table: 2-2) given from the RnD of the factory to the transformer section, which is passed to the worker associated to core assembly the work is done.

Table -: An example of Order sheet provided for Core assembling

5 MVA – REB		
Core Diameter	C / D	330 mm
Window Height	W / H	970 mm
Lack Centre	L / C	592 mm
Yoke Centre	Y / C	1290 mm
Sheet Material – Silicon Steel		Sheet Thickness – 2.8 mm

Stack Number vs Configuration		
Stack No	Stack Width	Total Stack
1	320	50
2	310	20
3	300	15
4	290	12
5	270	20
6	240	22
7	200	22
8	160	15
9	120	12

Starting from the lowest stack (Table: 2-2, stack no 9) the core assembling for bottom stack is started. The job runs to the upward stack direction (Table: 2-2, stack no 9 to 2). After that, the middle stack (Table: 2-2, stack no 1) is placed. Then, reversing the pre noted process, the top stacks are arranged (Table: 2-2, stack no 2 to 9).

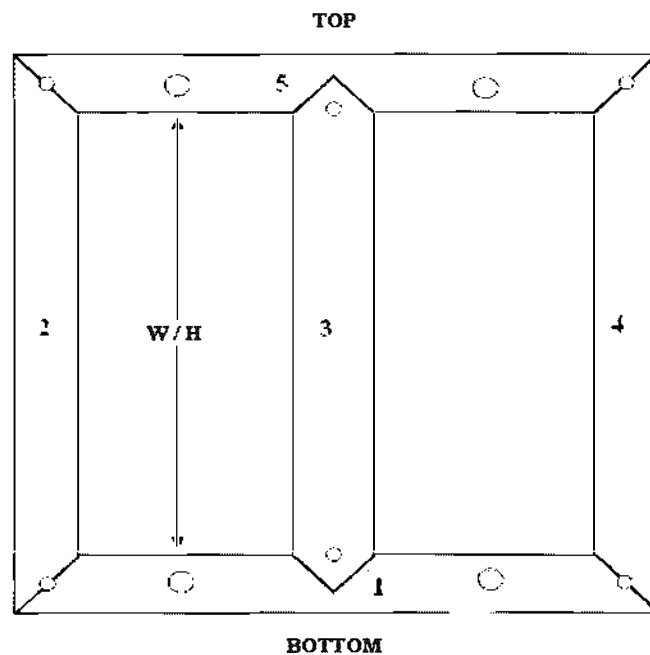

Figure -: Geometrical view of core assembly

Undergraduate Internship Report

The cores are arranged in a pre decided order. An example is given in figure 2-7. Here the number 1, 2, 3, 4, 5 indicates the order of core positioning. At first the no 1 core is placed then by rotationally at last no 5 core is placed. This happens for every stack of core positioning. But the process of this positioning is not fixed. It may vary with the design. After positioning a single core of the first stack the channel with core looks like figure 2-8.



Figure -: Core setting at beginning

After completing all stacks positioning, another press board is set and 3 more flitch plates are set. After that the rest two channels is set. Then, both the channel with the core is tied with foot plate, which helps to keep the core stand vertically (figure 2-9) for the next procedure.

2.8.3. Vacuum drying plant

With the help of electrical self-heating or vacuum drying, or both of them it is to be ensured that the transformer's core and coil is completely free of water vapor. For both power and distribution transformer at first the coil is taken into this process before the core coil assembling.

2.8.4. Top yoke out

The 3 limb is tied up with high voltage tape and fiber tape. The high voltage tape keeps the fiber tape safe against the sharp corner of the core plate.

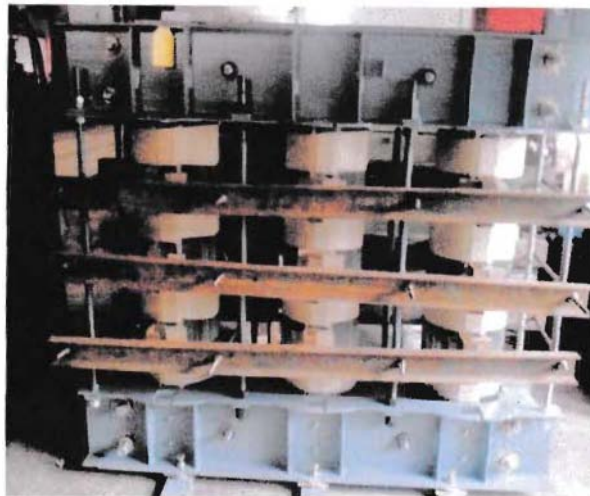

Figure -: Core with channel placed vertically

With the help of the over-head crane, the core with channel & foot plate is taken vertically (figure 2-9) to take out the top stacks (figure 2-7). The process of taking out the top stacks is called 'top yoke out' (figure 2-10). This is an important process for core coil assembly.



Figure -: A screenshot after removing Top yoke

2.8.5. Core coil assembly

After the top yoke is removed, all the components except bottom foot plate (figure 2-11) are removed. Then, press board is surrounded around the core in circle making way (figure 2-11, middle & right limb). The purpose of this press board is ensuring insulation between core and LT coil winding.

After completing the task of press board, the LT coil, taken before from the coil winding division is putted over the press board (figure 2-11, Left limb).



Figure -: Core coil assembly

Again, for insulation, press board is surrounded over the LT coil, according to the instruction of RnD. Then HT coil is taken from the coil winding division and is putted over the press board (figure 2-12). Then 2 press board sheets are put inside the 3 limb (figure 2-12) for insulation of one phase with another phase.



Figure -: Core assembly completed, waiting for top yoke fill

2.8.6. Top yoke fill

At first Top channels are set again (figure 2-13) before top yoke fill. After the top yoke fill, the lead connections are taken out from both LT & HT coil.

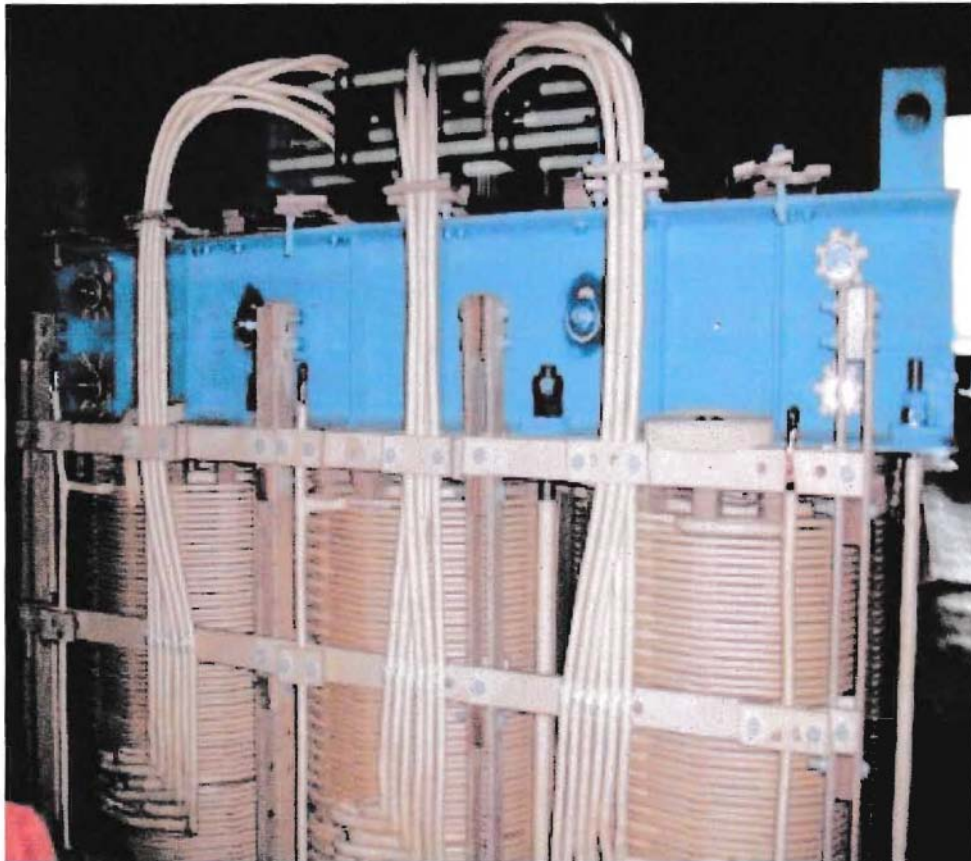

Figure -: Transformer with off load tap changer

2.8.7. Tap changer setting

At first the tap connections are taken out from the HT coil or Taping coil as designed. Then the tap changer is set to its position (figure 2-13, figure 2-16) according to the designed instruction. Now the connection lead of the taping coil is connected to the tap changer according to its configuration. The details discussion about tap changer is done in the section 2.9.

Undergraduate Internship Report

2.8.8. Tanking

After tap changer setting some in process test is done. If the test result is good then the transformer is taken for tanking. After that all fittings like Busing, Buckholtz Relay, and other metering and protecting equipments are assembled.



Figure -: Transformer ready to dispatch

2.8.9. Vacuum drying plant

Transformers go through extensive drying processes in different state. With the help of electrical self-heating or vacuum drying, or both of them it is to be ensured that the transformer is completely free of water vapor. After tanking and before the cooling oil pouring the vacuum drying process is done for the final time. This helps prevent corona formation and subsequent electrical breakdown under load.

2.8.10. Oil filling

After tanking some in process test is done. If the test result is good then the transformer is taken for oil filling with the help of a compressor. Transformer oil is mainly insulating oil which is stable at high temperatures for an extended period. Its key purposes are to provide electrical insulation between internal live parts and specially serving as a coolant. Moreover it holds down corona & arcing. It is mainly used in oil-filled transformers. After oil filling the transformer is taken for routine test. If the results of the tests are good then the transformer is ready for dispatching (figure 2-14).



2.9. Tap Changer

Tap-changer adjusts the turn ratio of the primary and secondary windings to the changing load ratios. It enables voltage regulation of the output sensing the input voltage by allowing a certain number of turns to be selected. It is one of the major parts of a transformer.

2.9.1. Types of tap changer

Two types of tap changers are available. They are used according to the demands of customer.

- ✚ On load tap changer
- ✚ Off load tap changer

2.9.2. On load tap changer

The on-load tap-changer consists of the diverter switch with the tap selector attached underneath. The diverter switch insert is installed in the oil compartment. The on-load tap-changer is attached to the transformer cover by means of the on-load tap-changer head. If required, the tap selector is equipped with a change-over selector.

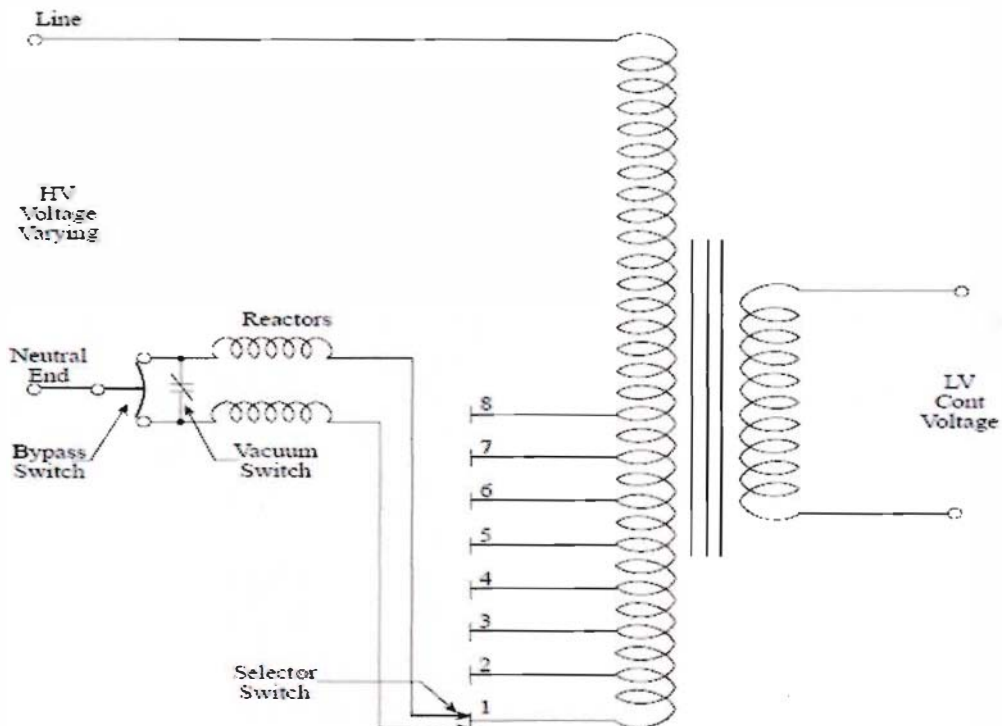

Figure :- On load Tap Changer working circuit diagram

2.9.3. On load tap changer vital equipment

An on-load tap changer is constructed by assembling various equipments. Among all of them the name of some vital equipment is listed below.

- *Diverter switch oil compartment*
- On-load tap-changer head and built-in diverter switch
- *Tap selector*
- Motor-drive
- *Drive shaft with coupling parts*
- Bevel gear
- Guard plate
- *Protective tube*
- Protective relay

2.9.4. Tap changer working example

A tap changer changes the turn ratio of primary to secondary by changing the tap position. The table stated below is to show that varying turn ratio and varied output voltage and current for different tap position.

Table -: An example of Tap changer working

TAP POSITION	HV PHASE VOLTAGE (V)	LV PHASE VOLTAGE (V)	HV PHASE CURRENT		LV PHASE CURRENT	
			ON 20 MVA BASE (AMPS)	ON 25 MVA BASE (AMPS)	ON 20 MVA BASE (AMPS)	ON 25 MVA BASE (AMPS)
1	138600 / $\sqrt{3}$	11000	249.94	312.42	1818.18	2272.73
2	136950 / $\sqrt{3}$		252.95	316.18		
3	135300 / $\sqrt{3}$		256.03	320.04		
4	133650 / $\sqrt{3}$		259.19	323.99		
5 (N)	132000 / $\sqrt{3}$		262.43	328.04		
6	130350 / $\sqrt{3}$		265.75	332.19		
7	128700 / $\sqrt{3}$		269.16	336.45		
8	127050 / $\sqrt{3}$		272.66	340.80		
9	125400 / $\sqrt{3}$		276.24	345.30		

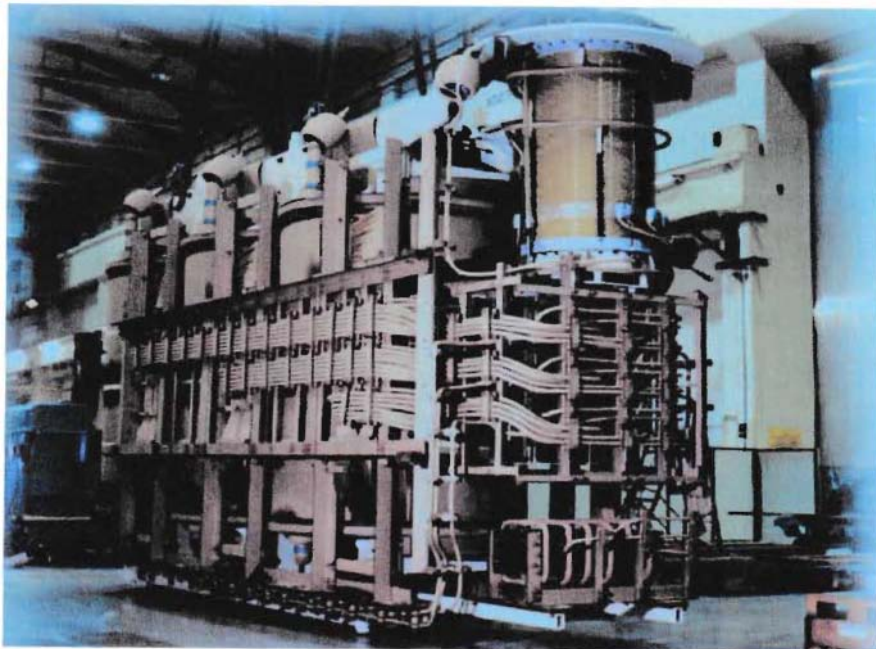

Figure -: A 75 MVA Power Transformer (with on load tap changer)

The above picture (figure 2-17) is of a power transformer with an on-load tap changer connected. It is a 3 phase transformer. The tap changer connected to the transformer is also a 3 phase on-load tap changer. It is clear from the above picture that the 3 different phase of transformer is connected separately with the tap changer. To change a tap position in the purpose of changing voltage the all the 3 tap position is changed together. The picture below (figure 2-18) is to show the driving box of the on-load tap changer.

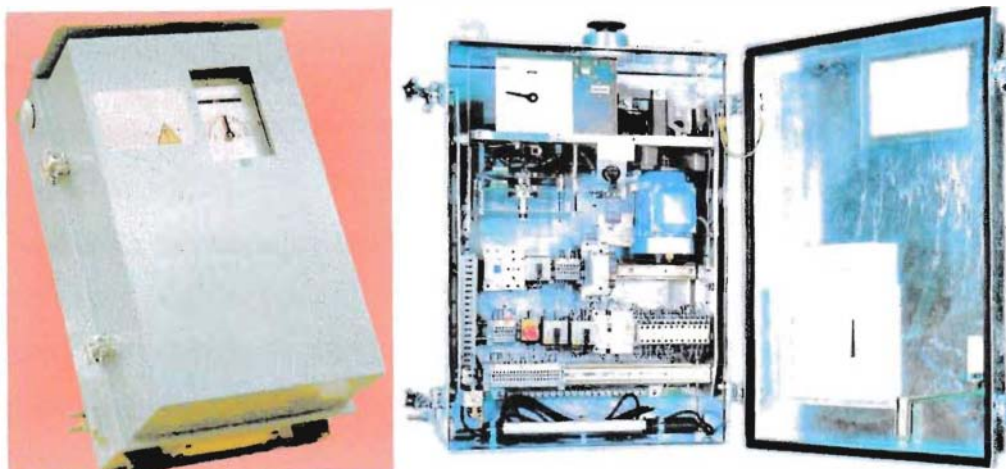

Figure -: On load tap changer driving box a) outer view b) Inner view

2.9.5. Nameplate of on load tap changer driving box

ABB Power Technologies AB		Ludvika Sweden		CE	MADE IN SWEDEN
On-load tap changer		Motor-drive mechanism			
Type	UBBRN 350/400	Type	BUE		
Number of pos. 27	No. 8607 800	Motor supply	3-50Hz 380-420 V		
201 A Stepvoltage	830 V 50 Hz	Contactors	50Hz 220-230 V		
Transition resistance	4.1 ohm	Position transmitter	AC 220-240 V		
Estimated contact life operations		Heating element	208-240 V		
Standards IEC 214 (1989-07)		Year of manufacture 2001			
Maintenance after 100000 operations or at least every 5 year, whichever comes first. Inspection once a year.					
CAUTION					
<p>The motor-drive mechanism must be protected against condensation. Energize the heater when power is available. When not, put drying agent inside the motor drive cabinet and seal the vents.</p>					

Figure -: Nameplate of a Driving Box of Tap Changer

The above picture (figure 2-19) is of the nameplate driving box of an on-load tap changer. From the nameplate the information the number of tap position for the driving box, motor power supply, estimated contact life etc. could be observed.

2.9.6. Control selection

Control selection switch is used to change the control of an on-load tap changer of a transformer for different operational purpose and to change the tap position. The control selections are stated below.

- Control selector switch, Position: Local - 0 - Remote.
- Control switch, Position: Raise - 0 - Lower.
- Hand crank for manual operation.



Figure -: An example of control switch indicator of a tap changer

▣ Local control

Control selector switch (S1) in LOCAL position. To change the tap position manually, the control position is set to LOCAL position.

▣ Remote control

Control selector switch (S1) in position REMOTE. To change the tap position automatically, the control position is set to REMOTE position. The control supply for the remote push buttons is then received from a terminal in the motor-drive cabinet.

*** Local operation is not possible when switch (S1) is in position REMOTE and remote operation is not possible in position LOCAL.

2.9.7. Indicators

Four visible indicators through the window in the door of Driving Box:

- Mechanical position indicator
- Drag hands for maximum & minimum position indication
- Tap-change in progress indicating red flag
- Operation counter

2.10. Production Process Flow Chart of Power Transformer

The production process of a power transformer is divided into some phase and some sub phase. The difference with the power transformer and distribution transformer in production process is that the radiator is not fixed with the tank of power transformer while the radiator is fixed with the tank of distribution transformer. The production phases are expressed as a form of work process flow chart stated below.

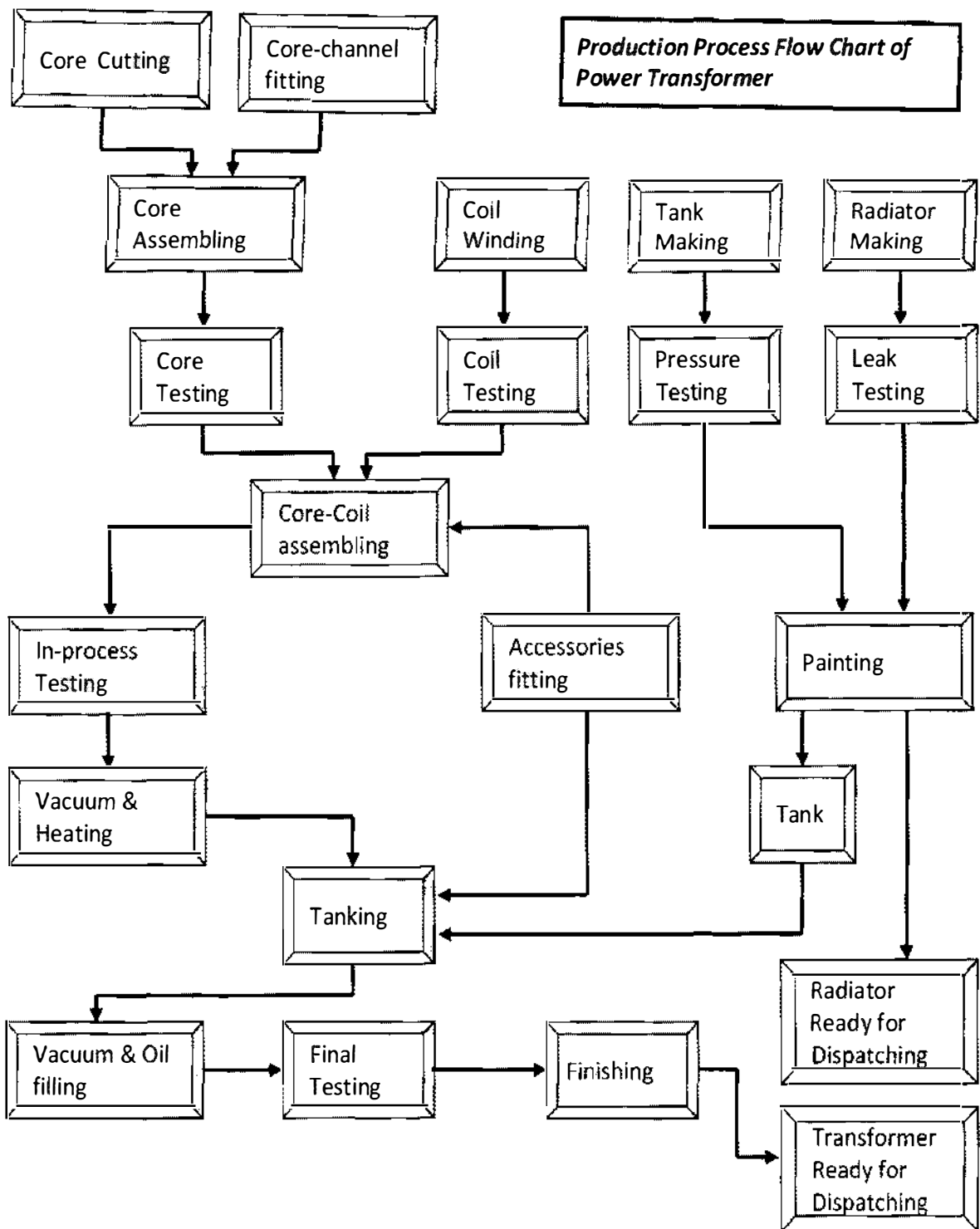

Figure -: Production process flow chart of power transformer

2.11. Nameplate of a Power Transformer

A nameplate of a power transformer gives almost all necessary information about the transformer. An example is given below.



AN ISO 9001 & 14001 CERTIFIED COMPANY

NAMEPLATE

SINGLE PHASE STEP- UP GENERATING TRANSFORMER

TYPE OF COOLING		<u>ONAN / ONAF</u>				
RATED KVA		<u>20000 / 25000</u>				
PHASE		1				
RATED VOLTAGE	HV	132 / $\sqrt{3}$				
	LV	11				
RATED LINE	HV	262.43 / 328.04				
CURRENT (AMP)	LV	1818.18 / 2272.73				
POLARITY		SUBTRACTIVE				
% IMPEDANCE		17.460				
TEMP RISE	°C TAP OIL	55				
AVG. WDG		60				
YEAR OF MFG		2011				
DIAGRAM DRG NO		TR1-A3-PP25MS-04				
STANDARD		IEC-60076				
FREQUENCY	HZ	50				
INSULATION LEVEL	HV	KV	L1	650	AC	275
	HVN	KV	L1	95	AC	38
	LV	KV	L1	75	AC	28

Undergraduate Internship Report

CORE & COIL	KG	20300
TANK & FITTINGS	KG	11000
MASS OF OIL	KG	12700
TOTAL MASS	KG	44000
TRANSPORT MASS	KG	34000
VOLUME OF OIL	L	14600
MAKERS REF. NO		
MAKERS SERIAL NO		20 / 25 – 31
CUSTOMER REF. NO		xxxxxx

RATING PLATE FOR A PHASE

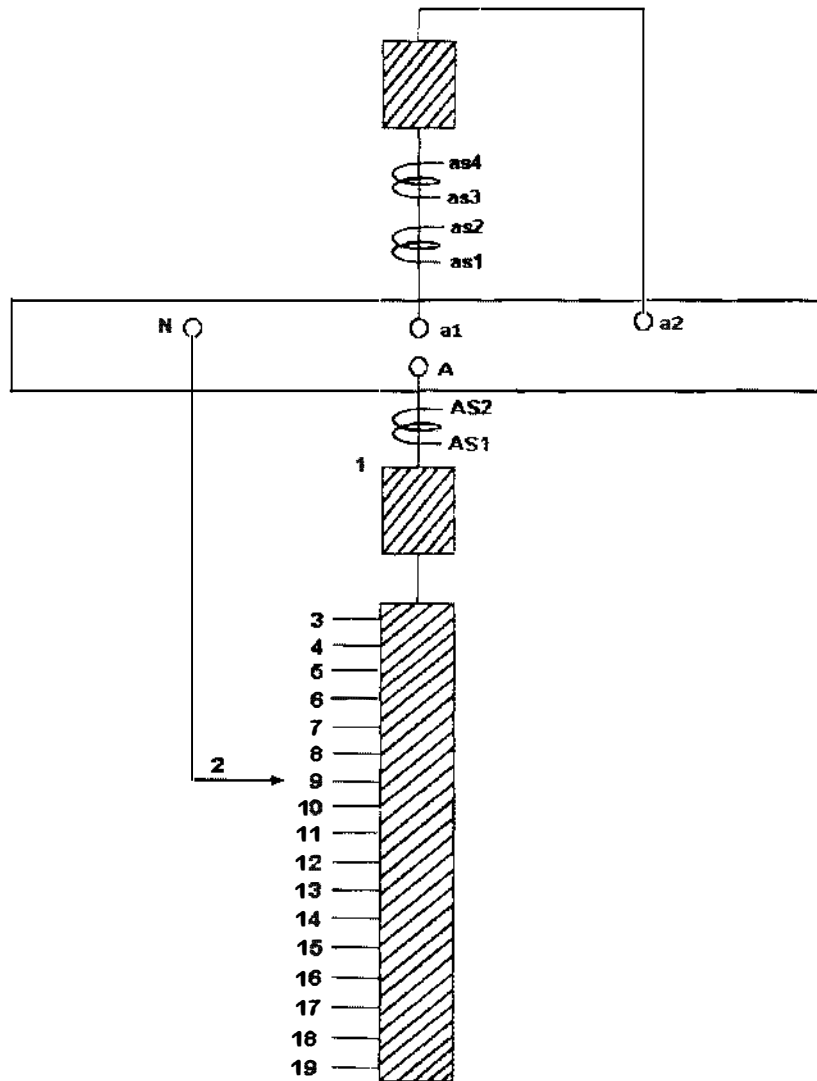

Undergraduate Internship Report

TAP POSITION	TAP SELECTOR CONNECTION	HV PHASE VOLTAGE (V)	LV PHASE VOLTAGE (V)	HV PHASE CURRENT		LV PHASE CURRENT	
				ON 20 MVA BASE (AMPS)	ON 25 MVA BASE (AMPS)	ON 20 MVA BASE (AMPS)	ON 25 MVA BASE (AMPS)
1	2 - 19	145200 / $\sqrt{3}$	11000	238.57	298.21	1818.18	2272.73
2	2 - 18	143500 / $\sqrt{3}$		241.32	301.64		
3	2 - 17	141900 / $\sqrt{3}$		244.12	305.15		
4	2 - 16	140250 / $\sqrt{3}$		247.00	308.74		
5	2 - 15	138600 / $\sqrt{3}$		249.94	312.42		
6	2 - 14	136950 / $\sqrt{3}$		252.95	316.18		
7	2 - 13	135300 / $\sqrt{3}$		256.03	320.04		
8	2 - 12	133650 / $\sqrt{3}$		259.19	323.99		
9 (N)	2 - 11	132000 / $\sqrt{3}$		262.43	328.04		
10	2 - 10	130350 / $\sqrt{3}$		265.75	332.19		
11	2 - 9	128700 / $\sqrt{3}$		269.16	336.45		
12	2 - 8	127050 / $\sqrt{3}$		272.66	340.80		
13	2 - 7	125400 / $\sqrt{3}$		276.24	345.30		
14	2 - 6	123750 / $\sqrt{3}$		279.93	349.90		
15	2 - 5	122100 / $\sqrt{3}$		283.71	354.63		
16	2 - 4	120450 / $\sqrt{3}$		286.03	357.53		
17	2 - 3	118800 / $\sqrt{3}$		291.59	364.49		

	RATIO	TERMINAL MARKING	ACCURACY CLASS	BURDEN (VA)	QTY	PURPOSE
HV BCT	400/1 A	AS1 - AS2	5P20	15	1	DIFF. PROTECTION
LV BCT	2800/1 A	AS1 - AS2	5P20	15	1	DIFF. PROTECTION
WTICT	2273/5 A	AS3 - AS4	0.5	15	1	THERMAL IMAGE

FOR THREE PHASE BANK VECTOR GROUP WILL BE YNd1
ENERGY PAC ENGINEERING LTD.
MADE IN BANGLADESH

Undergraduate Internship Report

2.12. Checklist for Any Normal Transformer

A transformer consists of different accessories and parts. To manufacture a transformer different raw materials and trimmings is needed. A checklist of a normal transformer is given below.

- | | | |
|--|----------------------------|--------------------------|
| 1. Core | 25. Pressure Screw | 50. Oil Level Gauge |
| 2. Die for Core | 26. Tank Body | 51. Press Board |
| 3. Die for Key Block | 27. Top Cover | 52. LT Terminal |
| 4. Core Channel | 28. Header Pipe | 53. HT Terminal |
| 5. Flitch Plate | 29. Radiator | 54. Pern Wood |
| 6. Transformer Feet | 30. Radiator Fan | 55. Arcing Horn |
| 7. Tie Rod | 31. Fan Bracket and Casing | 56. Connector |
| 8. Core Bolt | 32. Radiator Valves | 57. Nameplate |
| 9. Fiber Tube | 33. Valve Fixing Nut-Bolts | 58. Phase Plate |
| 10. Collar | 34. Air Breathing Plug | 59. Valve Plate |
| 11. Teak Wood | 35. Explosion Vent | 60. Logo Plate |
| 12. Bakelite Cylinder | 36. 0.8 mm Bakelite | 61. J.T and HT Ring |
| 13. Binding Hoop | 37. TC Mounting | 62. Busing |
| 14. LT Conductor | 38. HT CT With Box | 63. Shorting Bus Bar |
| 15. HT Conductor | 39. LT CT With Box | 64. Tapping Leads |
| 16. Tapping Conductor | 40. WTI CT | 65. Connector |
| 17. Metal Jacket | 41. LTC With Drive Box | 66. RTCC |
| 18. Key Strip | 42. Surge Relay | 67. Marshalling Box |
| 19. Key Block | 43. Buckholtz Relay | 68. Wheel and Wheel Assy |
| 20. Press Board Cylinder | 44. Valves | 69. Primer Paint |
| 21. 1 mm Press Board | 45. Pipes | 70. Epoxy Paint |
| 22. 2 mm Press Board | 46. Pressure Relief Valve | 71. Testing |
| 23. 3 mm Press Board | 47. WTI | 72. Trans Oil |
| 24. Coil Presser Ring – 50
mm Thickness | 48. OTI | |
| | 49. MOG: NOS | |

1.15. Some important parts of transformer

In this section some important external parts and their necessity & application of transformer is described.

1.15.1. Radiator & Radiator fan

To keep good efficiency, transformers need to dissipate the heat they generate during operation. Such heat dissipation (cooling) is mainly obtained via external radiators by natural convection. In case of high power transformers external cooling fans are also used.

Radiators are used in a transformer to cool the transformer oil through natural air or forced air flowing in these radiator fins. As the transformer oil temperature goes down due to cooling, it goes to the transformer tank from bottom. By cooling the windings it gets heated and then it returns to the radiator for next cooling operation. This cycle repeats as the oil flow is also natural due difference in temperature of oil on bottom and top. In case of large transformer, external radiator fan is also used to cool the radiator instantaneously. In big power transformers oil circulation is forced by oil pumps for effective cooling. The radiator has many small fins and 4-10 radiator fins make a radiator bank in a transformer depending on the load and design of the transformer.

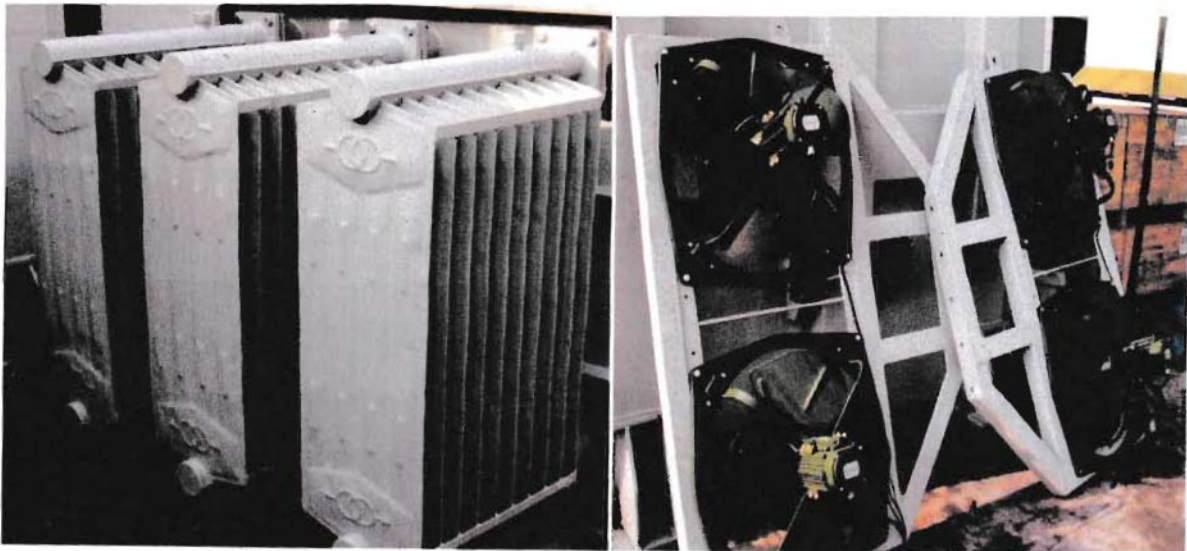

Figure 0-22: Radiator and Radiator Fan of a transformer



2.13.2. Conservator

It is used to provide adequate space for the expansion of oil when transformer is loaded or when ambient temperature changes. Conservator is a type of tank, used to help oil filling this is situated upper portion of the power transformer. Mainly these are cylindrically shaped.



Figure -: Conservator Tank of a transformer

2.13.3. Protecting components

Oil filled transformers with a conservator (an oil tank above the transformer) tend to be equipped with Buchholz relays. These are safety devices that detect the build up of gases inside the transformer as a side effect of corona or an electric arc in the windings and switch off the transformer. Transformers without conservators are usually equipped with sudden pressure relays, which perform a similar function as the Buchholz relay.

2.13.4. Buchholz relay

It is a very sensitive gas and oil operated instrument which safely detect the formation of gas or sudden pressure inside the oil transformer. This is a double ended device one end is connected to conservator other is connected to tank. There are two windings inside the relay one for detecting oil level going to empty and other is connected to an alarm circuit for warning.

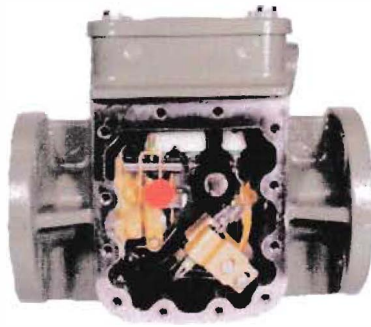

Figure -: An example of Buckholtz Relay

2.13.5. Silica gel breather

It sucks the moisture from the air which is taken by transformer. This is how dry air is taken by transformer. A chemical material inside the breather basically silica gel is used. Normally it is brown colored but after the absorption silica gel become pink.



Figure -: example of Silica Gel Breather

2.13.6. HT & LT bushes

Allows a conductor to pass along its centre and connect at both ends to other equipment is the use of bushing. Bushing varies both in ceramics & conductor size for the variation of current and voltage condition of load. For higher voltage, bushing Disc diameter & height is higher and for higher current, bushing lead diameter is higher.



Figure -: Bushing of a transformer

2.13.7. Marshaling box

Marshaling box is a combination of Oil Temperature Indicator (OTI) and Winding Temperature (WTI) used to identify the oil temperature and winding temperature.



Figure -: An example of Marshaling Box assembled in Energypac



Figure -: OTI and WTI used in marshaling box.

2.13.8. Air vent

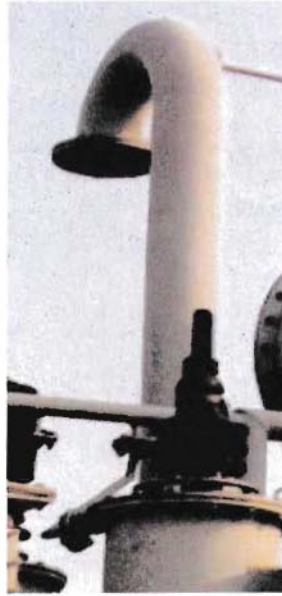

Figure -: An example of an air vent

Air vent is used to ensure safety for the situation when huge pressure induced inside the transformer due to any malfunction.

2.13.9. Drain valve

This valve is used for taking damaged oil from the oil tank for the proper oil collection this valve is situated under the oil tank.

The chapter gives a complete idea about the manufacturing process involved with power transformer and distribution transformer at Energypac Engineering Ltd. To do so, different important process related to transformer manufacturing is discussed in this chapter. It consists of the process of cutting and setting of core from the core material, winding the coil from copper conductor, assembling of core and coil, setting tap changer etc. Except that many little but important process like top yoke out, top yoke fill is also included here. The necessity of different trimmings like radiator, bushing, silica gel etc. is also discussed in this chapter. To sum up; this chapter covers a brief idea about how a transformer is manufactured from the raw material to a complete transformer.

CHAPTER 03

TEST OF TRANSFORMERS

Two different days (May 07, 2011 & May 15, 2011), I worked at High Voltage Testing Lab under the supervision of Engr. Asim Kumar Bhakta, Manager, High Voltage Testing Lab. At the beginning of every single day, I was given some ideas about the upcoming routine test to be conducted at that very day. The in process test of the transformer was observed at previous days while working at transformer section (May 02, 2011 - May 05, 2011). This chapter will provide the method and data of testing power transformer and distribution transformer at the transformer section and high voltage lab. Some in process test like continuity test, ratio test, megger test; some routine tests like measurement of winding resistance, no-load loss and no-load current test, vector group test, will be discussed in this chapter.

3.1 In process test of transformers

The in process test is the test which is done at the time of manufacturing a job. The name of some in-process tests done for the transformer is listed below.

- Continuity Test
- Ratio Test
- Megger (Insulation Resistance Test)
- Magnetic Balance Test

Undergraduate Internship Report

3.1.1. Continuity test

This test is done to identify the coil continuity after the completion of coil winding & core coil assembly. It is conducted with the help of a multimeter. An open circuit cannot conduct electricity but a closed circuit can conduct electricity as it has continuity is the basic concept of this test.



Figure -: Multimeter used for continuity test.

3.1.2. Ratio test

Transformer Turns Ratio is the ratio of the number of turns in the high voltage (HT) winding to that in the low voltage (LT) winding. This test is done after core coil assembly under in process test and again after the job is done under routine test. A Transformer Turns Ratio Test Set can directly measure the ratio of most types of transformers. If a transformer ratio changes more than 0.5 percent from the rated voltage ratio, it may not operate reliably. To measure small ratio changes such as this, higher accuracy level is needed.



Figure -: ATRM - 200, Automatic Transformer Ratio Meter

Table -: An example of Ratio Test result sheet

Ratio Test							
150 KVA, 3000 KVA							
11 / 0.415 KV							
Dyn 11							
Measurement of Ratio for Different Tap Position					Actual Value		
HT Voltage (V)	LT Voltage (V)	Ratio	+ 0.5%	-0.5%	Phase A	Phase B	Phase C
11275	415	47.05	47.28	46.80	47.01	47.02	47.04
11000		45.90	46.12	45.67	45.84	45.86	45.84
10725		44.76	44.98	44.53	44.66	44.67	44.69
10450		43.61	43.82	43.39	43.52	43.53	43.57
10175		42.46	42.67	42.24	42.35	42.39	42.44

3.1.3. Megger (insulation resistance test)

This test is actually done on the basis of Megohmmeter with a timed test function.



Figure -: An example of Megohm meter (Megger) used in Energypac

For this test the Megohmmeter is connected across the windings of the transformer coil. A DC test voltage of 2500 V or 5000 V is applied for 60 seconds and the reading is taken. If the value is more than 1000 MΩ then the insulation level is considered as good.

Undergraduate Internship Report

3.1.4. Magnetic balance test

The Magnetic Balance test is conducted on Transformers to identify the inter turn faults and magnetic imbalance. The magnetic balance test is usually done on the star side of a transformer. A two phase supply 440V is applied across two phases. Another phase is kept open. The voltage is then measured twice, each between one of the first two phases and open phase. The sum of these two voltages should give the applied voltage.

For instance, if the voltage applied is 440V, then the voltages obtained can be 240 V & 200 V, as, $440V = 240V + 200V$.

The voltages obtained in the secondary will also be proportional to the voltages above.

This indicates that the transformer is magnetically balanced. If there is any inter-turn short circuit that may result in the sum of the two voltages not being equal to the applied voltage.

The Magnetic balance test is only an indicative test for the transformer. Its results are not absolute. It needs to be used in conjunction with other tests.

Table -: An example of Magnetic Balance Test result sheet

Supply On		HV (Y)		LV Keep Open	
Supply Voltage		Measured Voltage		Measured Current	
Van	241.7 V	Vbn	196	Ia	1.91 mA
		Vcn	43.6		
Vbn	238.5	Van	119	Ib	1.55 mA
		Vcn	120		
Vcn	238.8	Van	47	Ic	1.98 mA
		Vbn	190		

3.2. Routine test of transformer

- Measurement of winding resistance
- Measurement of no-load loss and no-load current
- Vector group test
- Power frequency (separate source voltage) withstand test
- Ratio test
- Induced over voltage withstand test
- Measurement of Dielectric Strength of Transformer Oil

3.2.1. Measurement of winding resistance

The resistance of High Tension or Low Tension winding is tested by a digital Transformer Winding Resistance Meter. The connection diagram with TWRM 5 is given by the following figure (figure 3-4).

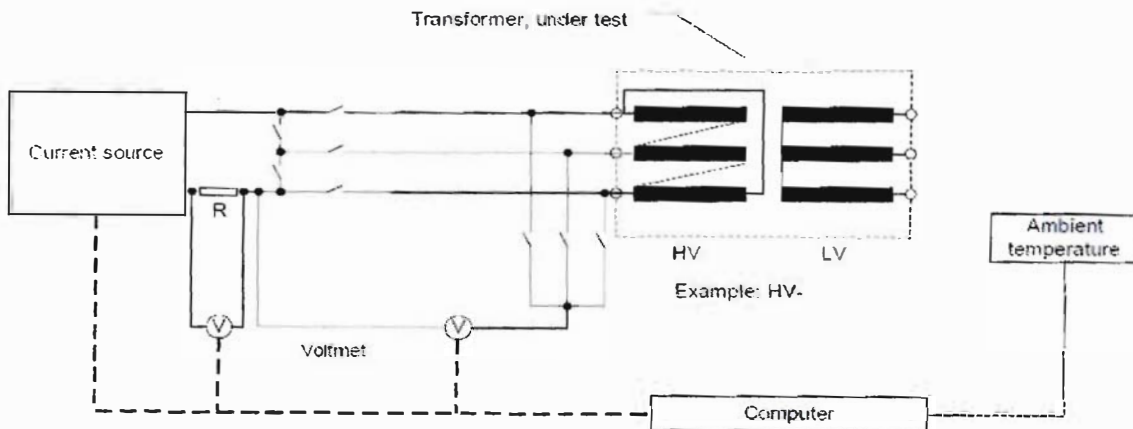

Figure -: Connection diagram for winding resistance measurement

Here, a DC current is injected by a “Test Current” terminals and the resistance of a coil is measured by their voltage drops.

Undergraduate Internship Report

3.2.2. No load test

The no load test is done according to wattmeter method. The transformer is energized from any side by applying the rated voltage of the side, keeping the other side open. As the transformer is energized by the rated voltage, so for easy job, usually the transformer is energized from the lower tension side.

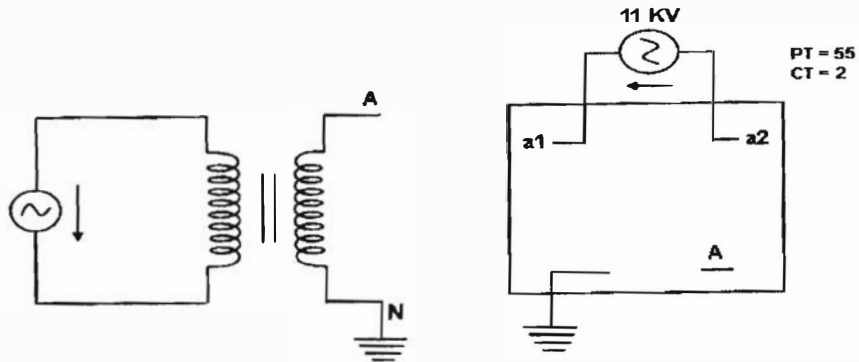

Figure -: Connection diagram of no load test

The transformer is in no load condition, so the power consumed by the wattmeter is no load loss.



Figure -: A screenshot of No load test Equipment panel

Table -: An example of No Load Test result sheet

No Load Test					
For 20 / 28 MVA; 33 / 11 KV - Power Transformer					
Test Frequency = 50 Hz ; Tap Position = 13 [Principle Tap]					
Applied Voltage = 11 KV					
Test Voltage (RMS) KV	No-Load Current I_0 (A)	Watt-Meter Reading W1 (KW)	Watt-Meter Reading W2 (KW)	Watt-Meter Reading W3 (KW)	Remark
$V_{an} = 6.36$	$I_a = 1.20$	1.53	3.33	8.53	CT Ratio = 2 PT Ratio = 55
$V_{bn} = 6.39$	$I_a = 0.98$				
$V_{cn} = 6.28$	$I_a = 1.36$				
$V_{avg} = 6.35 \text{ KV}$;		$I_{avg} = 1.18 \text{ A}$			
No load loss ($W1+W2+W3$) = 13.39 KW					

3.2.3. Vector group test

A vector group is the International Electro-technical Commission (IEC) method of categorizing the primary and secondary winding configurations of three-phase transformers. The Vector Group Test is done to get ensured the phase – relationship characteristics (vector group) between Primary and Secondary Winding of a Transformer as it was ordered by the customer.

There are some standardize symbols, used to show the phase-relation characteristics between primary and secondary windings. In the system adopted by the IEC, the vector group is indicated by a code consisting of two or three letters, followed by one or two digits. They are in general form:

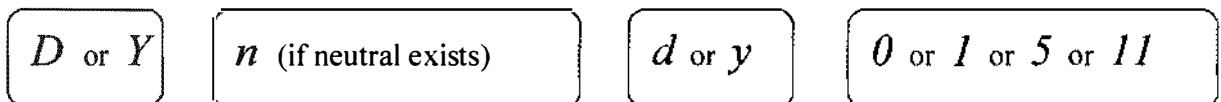

Undergraduate Internship Report

The capital letter symbolize HT side, the small letter symbolize LT side, in the letter “n” exists, it indicates the presence of neutral and the numeric indicates the phase – relationship.

D: Delta winding, also called a mesh winding. Each phase terminal connects to two windings, so the windings form a triangular configuration with the terminals on the points of the triangle.

Y: Wye winding, also called a star winding. Each phase terminal connects to one end of a winding, and the other end of each winding connects to the other two at a central point, so that the configuration resembles a capital letter Y. The central point may be connected outside of the transformer.

The conformation test of the Vector Symbol, Dyn-11 is done by shorting one primary terminal and one secondary terminal (let C_2 and c_2) and applying a little fraction of coil voltage in any side. The vector Group Test is done by shorting two points of two sides and applying a fractional winding voltage from primary side. Calculating the voltages of other points, the phasor diagram is obtained and the Vector Symbol is established.

The point of confusion is in how to use this notation in a step-up transformer. As the IEC60076-1 standard has stated, the notation is HV-LV in sequence. For example, a step-up transformer with a delta-connected primary, and star-connected secondary, is not written as 'dY11', but 'Yd11'. The 11 indicates the LV winding leads the HV by 30 degrees.

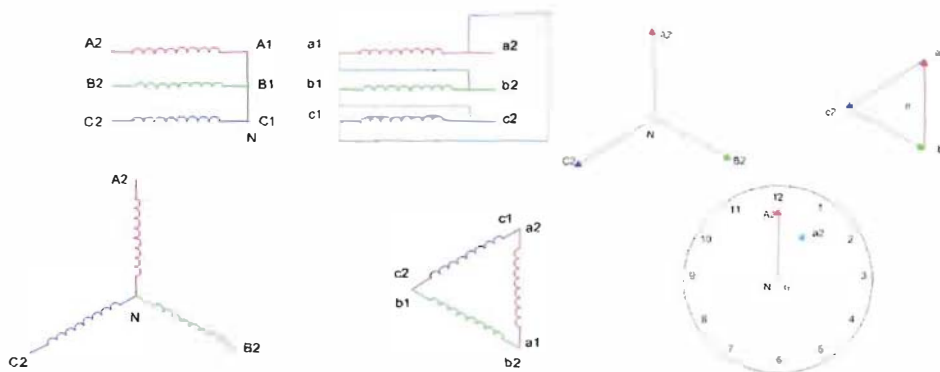

Figure :- Circuit diagram of Yd11 connection

3.2.4. Power frequency withstand test

During the operational time, switching time a transformer faces surges, from which a voltage is exerted which is higher than its operating voltage. The duration of the surge voltage is little, but the quick peaking property of the surge voltage makes it dangerous for a transformer.

To verify that a transformer is capable of withstanding at proper operation or not this test is done.

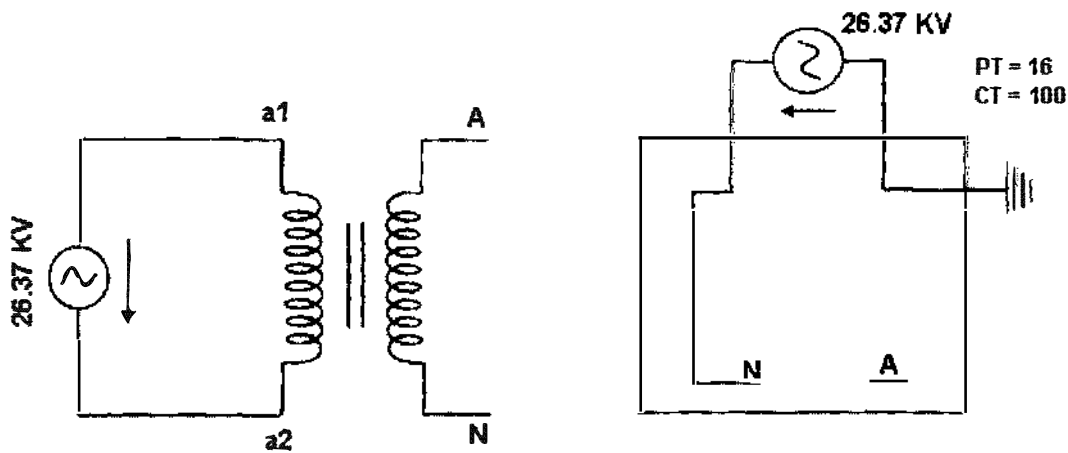

Figure - : Connection diagram for Power Frequency Withstand Test

High voltage is applied in LT side, which will be at least 2.5 times of the operating voltage. For 33 KV operating voltage 70 KV is applied, for 11 KV operating voltage 28 KV is applied. The transformer has to withstand the power frequency for at least 60 seconds.

The applied voltage is measured from the voltmeter and the very small amount of leakage current is measure by the ammeter. If the insulation breaks down or anything abnormal happen the leakage current value will be abnormally high.

3.2.5. Ratio test

Using the Automatic Transformer Ratio Meter, ATRM – 200 the ratio test is done. For different tap position the ratio test is done.

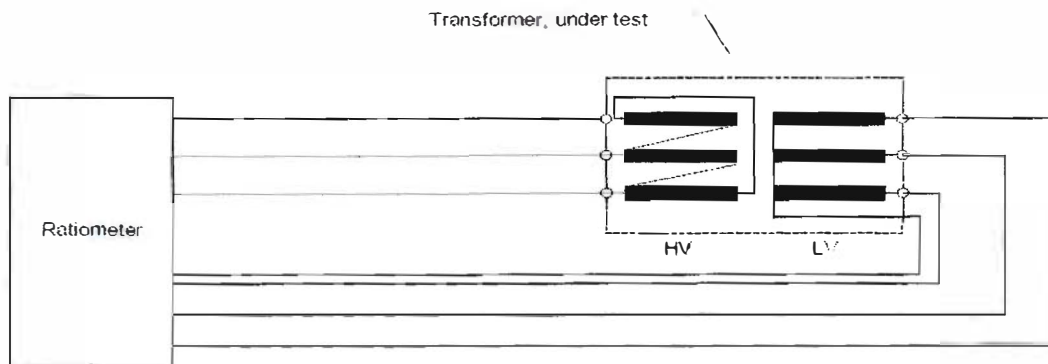

Figure :- Connection diagram for ratio test

In ratio test if the measured value is not always same with the rated value then it could be said that the vector group is not same. So from here we could be sure about the vector group. So vector group test is not always done.

3.2.6. Measurement of di-electric strength of transformer oil

The di-electric Transformer Oil has a very good Insulating property and Cooling property. This property helps it to withstand at high voltage. To verify that insulating property this test is done by applying High voltage to the oil sample. The high voltage (32 KV) is applied to the sample via a pair of electrodes, having a specific gap of 2.5 mm. The more breakdown voltage, the more insulating property of oil, better for use. The connection diagram is shown below:

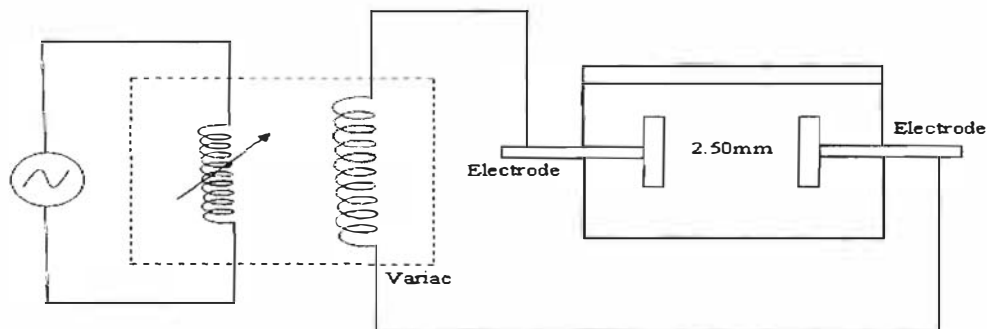

Figure :- Oil Tester Circuit



Figure -: An example of Oil Tester used at Energypac

3.3.Type Test

Type test are done after a long time for the certification of any new product. These tests are done for only one job of a certain lot. These tests are done for transformer to ensure the design is well estimated.

1. Temperature rise test
2. Measurement of insulation resistance
3. Measurement of capacity and tangent of insulation loss angle
4. Chopped wave impulse test
5. Measurement of acoustic sound level
6. Measurement of zero sequence impedance
7. Partial discharge measurements
8. Measurement of harmonics of on-load current
9. Measurement of power taken by the fan and oil pump motors
10. Short circuit withstand test.

Undergraduate Internship Report

3.4. High Voltage Lab Components

Some components name and its specifications are given at below with their images situated at high voltage lab of Energypac factory. These components are used for different type test and routine test. I could not observe any test done by these equipments. So only the picture and speciation are stated here.



Figure -: High voltage test components

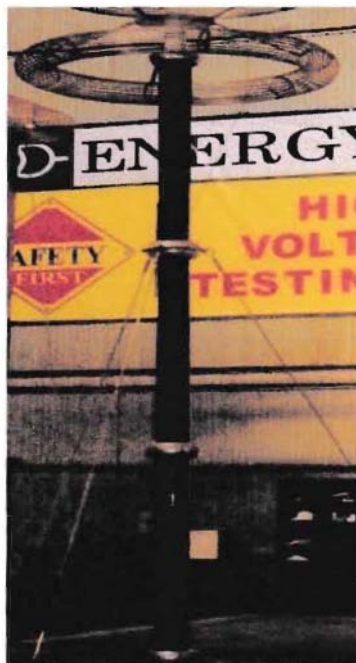

Figure -: Impulse voltage divider

Undergraduate Internship Report

Specifications of Impulse voltage divider

Rated Voltage	-	1600 KV
Power Capacity	-	412 nF
Model	-	HCR 1600 / 400
HV Arm	-	400 PF
Voltage Ratio	-	1031
Weight	-	440 Kg
Height	-	520 cm
Measuring Cable	-	75 Ω - 20m



Figure -: Multilevel Chopping Gap

Specifications of Multilevel Chopping Gap

Model	-	HMC 1200 / 600
Rated Capacitance	-	600 PF
Stage Voltage	-	600 KV
Weight	-	490 Kg
Rated Voltage	-	1200 KV
Stage Number	-	2
Stage Capacitance	-	1200 PF
Height	-	395 cm



Figure -: Impulse Voltage Generator

Specifications of Impulse Voltage Generator

Model	-	HG 1600 / 100
Rated Capacity	-	100 KJ
Stage Voltage	-	200 KV
Weight	-	2500 Kg
Rated Voltage	-	1600 KV
Stage Number	-	8
Stage Capacitance	-	625 μ F
Height	-	564 cm

This chapter gives a clear conception about the test done for the power transformer and distribution transformer at the transformer section and high voltage lab in the factory of Energypac Engineering Ltd. The entire test observed by me at the factory is only discussed in this unit. Some in process test like continuity test, ratio test, megger test, and magnetic balance test is discussed in this chapter. In addition, some routine tests like measurement of winding resistance, no-load loss and no-load current, vector group test, power frequency withstand test, ratio test, induced over voltage withstand test, and measurement of di-electric strength of transformer oil is also discussed in this chapter. The circuit diagram and the accessories related to the tests are also included here. Except that Energypac also conduct many type tests. As the type tests are done occasionally and I couldn't observed any type test so that part is not discussed in this chapter.

Chapter 04

4. SWITCHGEAR

It was the sixth day of my internship at 'Energypac Engineering Ltd', I was sent to Engr. Sayed Muztaba Ali, Section-in-Charge, switchgear section. He gave me a brief idea about switchgear section and the work done under the section. For next three days (May 08, 2011 – May 10, 2011), I worked at switchgear section under the supervision of Engr. Mahbubul Alam & Engr. Tauhid. This chapter will present a brief idea about the switchgear devices manufactured at the switchgear section of Energypac Engineering Ltd. The production process of vacuum circuit breaker and the in process tests carried out for vacuum circuit breaker will be integrated in this chapter. The assembly process of load break switch, LT switchgear, power factor improvement panel, will also be discussed in this chapter.

4.1. Introduction to Switchgear

Switchgear is an important term used in power system. It is a collection of electrical Disconnectors, Fuses, circuit breakers used to isolate electrical equipment. Mainly it is used as a circuit breaker. The other functions are monitoring, protecting, controlling as well as switching. According to the client requirement the parts, size, rating of the switch gear is varied. In this section some parts of switch gear are made, some are assembled and then tested.

All relays and microprocessors are imported. Circuit breakers up to 33 KV are made here; more than that is imported. Up to 230 KV Control circuit or system is designed here.

4.2. Types of Switch Gear

Two types of switchgear are manufactured at Energypac.

- HT Switch Gear
- LT Switch Gear

Undergraduate Internship Report

4.2.1. HT switch gear

These are high tension switch gears which are used in the high voltage line. There are two types of circuit breakers, which are prepared as the HT switch gear.

- ❑ 11 KV VCB and Control Panel
- ❑ 33 KV VCB and Control Panel
- ❑ 11 KV Load Break Switch (LBS)

4.2.2. LT switch gear

Those are low tension switch gears which are used in low voltage line. There are three types of circuit breaker are used in the LT.

- ❑ ACB (Air circuit breaker)
- ❑ MCCB (Molded case circuit breaker)
- ❑ MCB (Miniature circuit breaker)

4.2.3. Control panel

Different types of control panel of various rating according to the client demand are manufactured in this switch gear section.

- ❑ 33 KV incoming & outgoing panel
- ❑ 11 KV incoming & outgoing panel
- ❑ 132 KV, 230 KV Control panel
- ❑ 33 KV Bus coupler panel
- ❑ 33 KV Transformer panel
- ❑ 11 KV Metering panel
- ❑ RTCC Panel (On Load Tap Changer Panel)

4.2.4. Others products

Some other products are also manufactured at Energypac.

- ✚ Power factor improvement panel (PFI)
- ✚ Marshalling Box (OTI & WTI)

- ✚ Distribution board:
 - AC Distribution panel
 - DC Distribution panel

4.3. Vacuum Circuit Breaker (VCB)

A vacuum interrupter (figure 4-3) is used for disconnecting the circuit. VCB is used at above 500 KVA line.

4.3.1. VCB types

In the switchgear section of Energypac, two different types of VCB (figure 4-1) are manufactured.

- ✚ Indoor type
- ✚ Outdoor type



Figure -: Example of Indoor type VCB and Outdoor type VCB

All items of VCB are not manufactured at Energypac. Most of them are imported. At Energypac mainly the VCB are assembled.

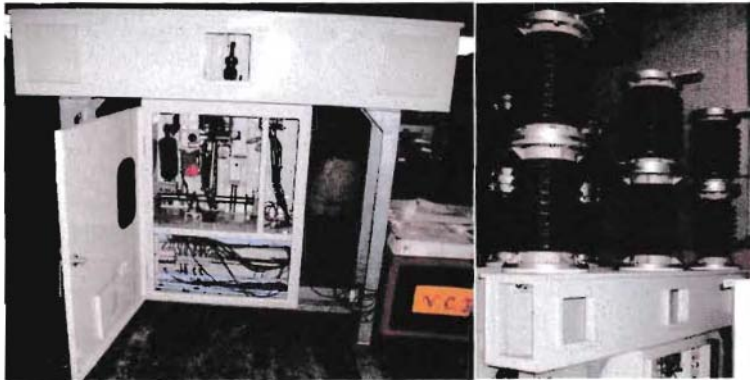

Figure -: A screenshot of Outdoor type VCB driving box; Upper side



Figure -: Indoor type VCB driving Box front view; internal view; VCB Interrupter

Undergraduate Internship Report

4.3.2. VCB items area specification

Some items needed for Vacuum Circuit Breaker manufacturing are listed at below with their names and area specification.

Table -: VCB items area specification

VCB Capacity	Imported Items	Local Items
11KV	AC Motor Limit switch (2NO + 2NC) Plug and Socket ON/OFF switch Vacuum interrupter Vacuum interrupter house Jaw connector Auxiliary Switch Mechanism Copper foil Copper terminal	Push button set Release link shaft Charging indicator
33 KV	AC Motor Limit switch (2NO + 2NC) Plug and Socket ON/OFF switch Vacuum interrupter Interrupter bushing & Support insulator Jaw connector Auxiliary Switch Mechanism Copper foil Aluminium terminal	Push button set Release link shaft Charging indicator

4.3.3. Process flow chart of HT switch gear (VCB)

Vacuum circuit breaker is mainly assembled in Energypac. In the previous page from items area specification it is clear that almost all important parts are imported. The manufacturing process with different phases of Vacuum Circuit Breaker is shown in below as a form of flow chart.

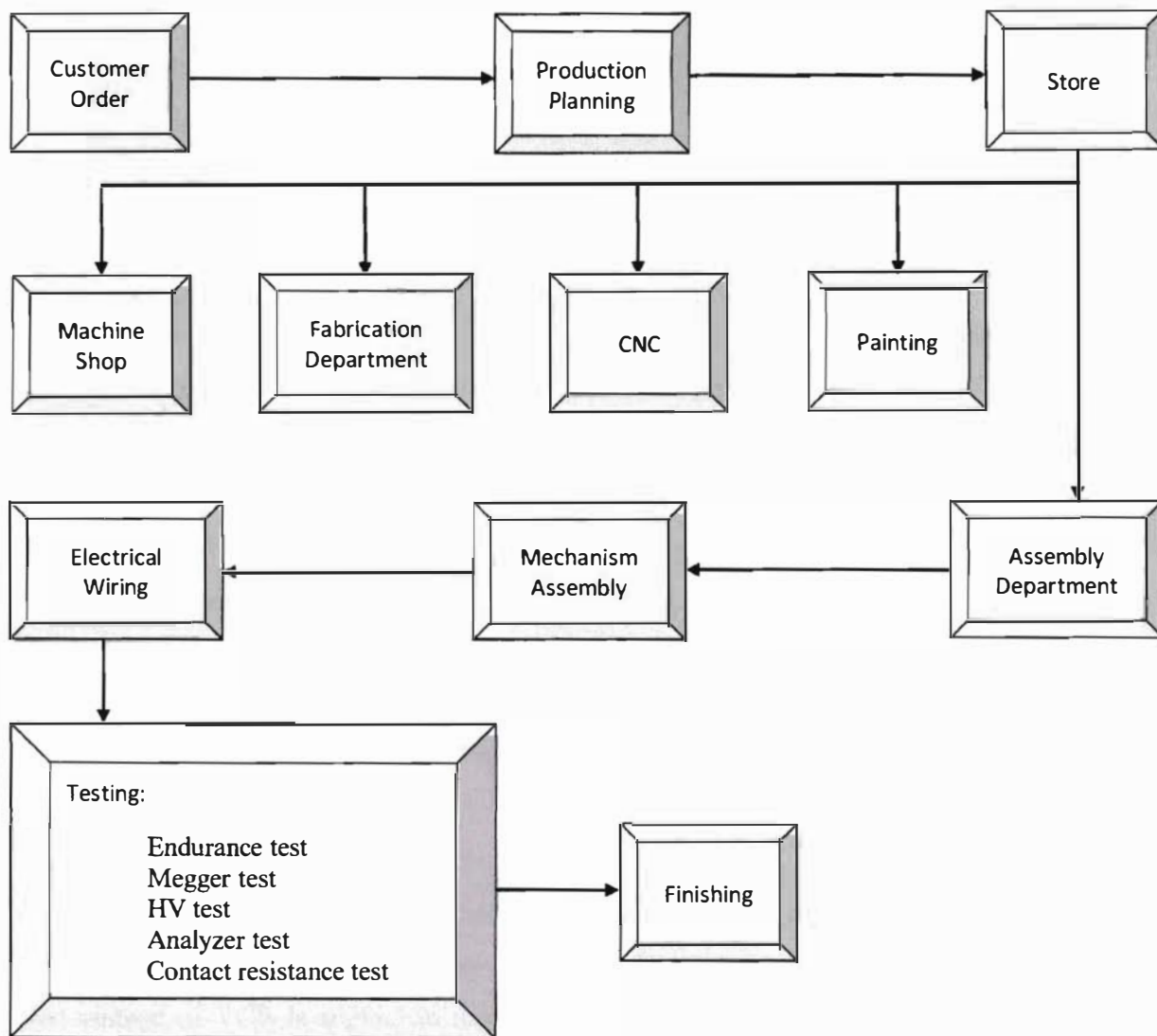

Figure :- Manufacturing process of a vacuum circuit breaker

Undergraduate Internship Report

4.4. VCB test

After completion of a job almost all the jobs are undertaken some tests as a routine test purpose in Energypac. To ensure the proper assembling and proper working of Vacuum Circuit Breaker in future, 5 different tests are done at Energypac for Vacuum Circuit Breaker.

- Endurance test
- Megger test
- HV test
- Analyzer test
- Contact Resistance Test

4.4.1. Endurance test

In this test the VCB is forced to operate several times. After 1000 times operation the physical condition of the device is checked to see whether the VCB is damaged or not. This is why this test is also called as fitness test of VCB.

4.4.2. Megger Test

The test is done to measure the insulation level of Vacuum Interrupter For this test the Megohmmeter is connected across the Vacuum Interrupter of the VCB. A DC test voltage of 2500 V or 5000 V is applied for 60 seconds and the reading is taken. If the value is more than 1000 M Ω then the insulation level is considered as good.

4.4.3. High Voltage Test

This test is done to measure the insulation level of vacuum interrupter at **off** mode and also to measure the insulation level of the body at **off** mode. A high voltage, normally 2.5 times than the rated voltage of VCB is applied to the Vacuum Interrupter and also to the VCB body to see whether the Vacuum Interrupter and the body of VCB can withstand at this voltage or not. If the Vacuum Interrupter and the body of VCB can withstand up to 60 second the test result is considered as good.

Undergraduate Internship Report

4.4.4. Analyzer test

At off mode using the analyzer, supply is given to the input (fixed) part of the Vacuum Interrupter. Then the impulse is checked. This test is actually done to know that the Vacuum Interrupter is working properly or not. If at off mode the receiver doesn't get any signal, then the Vacuum Interrupter is working properly. But, if at off mode the receiver gets any signal then the Vacuum Interrupter is considered as faulty.

At on mode the input is again given and the receiver takes the output. If the receiver gets a signal, then the Vacuum Interrupter is working properly, if not then the receiver is not working properly.

From the above two operation the opening time and closing time for the Vacuum Interrupter is also measured. If the opening time and closing time is within 30 msec, then the result is considered as good.

4.4.5. Contact Resistance Test

In this test the resistance between the fixed and movable contact is measured. A high voltage is applied for 1 minute to the fixed and movable contacts then the resistance is measured. If the result is more than 1000M Ω then the result is considered as good.



4.5. Load breaker switch

Load break switch (LBS) is an electric switch working under very high voltage (figure 4-4). LBS is capable of carrying a huge current without overheating the open position. LBS is equipped with arc interrupters to interrupt the load current. Load break switches are capable of making breaking currents under normal conditions. For the fault occurred in any phase, LBS isolate the whole three phases.



Figure -: Internal and external view of LBS

4.5.1. Main parts of LBS

A load break switch consists of different equipments. Some of them are manufactured at Energypac and others are imported. From different countries.

- Moving contact
- Moving contact nylon lever
- Typing lever set
- Fuse holder
- Insulator
- Arc shot
- Mechanical charging wheel
- Aluminum wheel
- Spring bracket
- Fixed contact base
- Limit switch
- Off spring
- Charging cam bearing
- Trip lever bearing

4.5.2 Process flow chart of HT Load Break Switch

The production process of Load Break Switch consists of different phases. The load break switch is mainly assembled at the switchgear section of Energypac. The production process is shown in below as a form of flow chart.

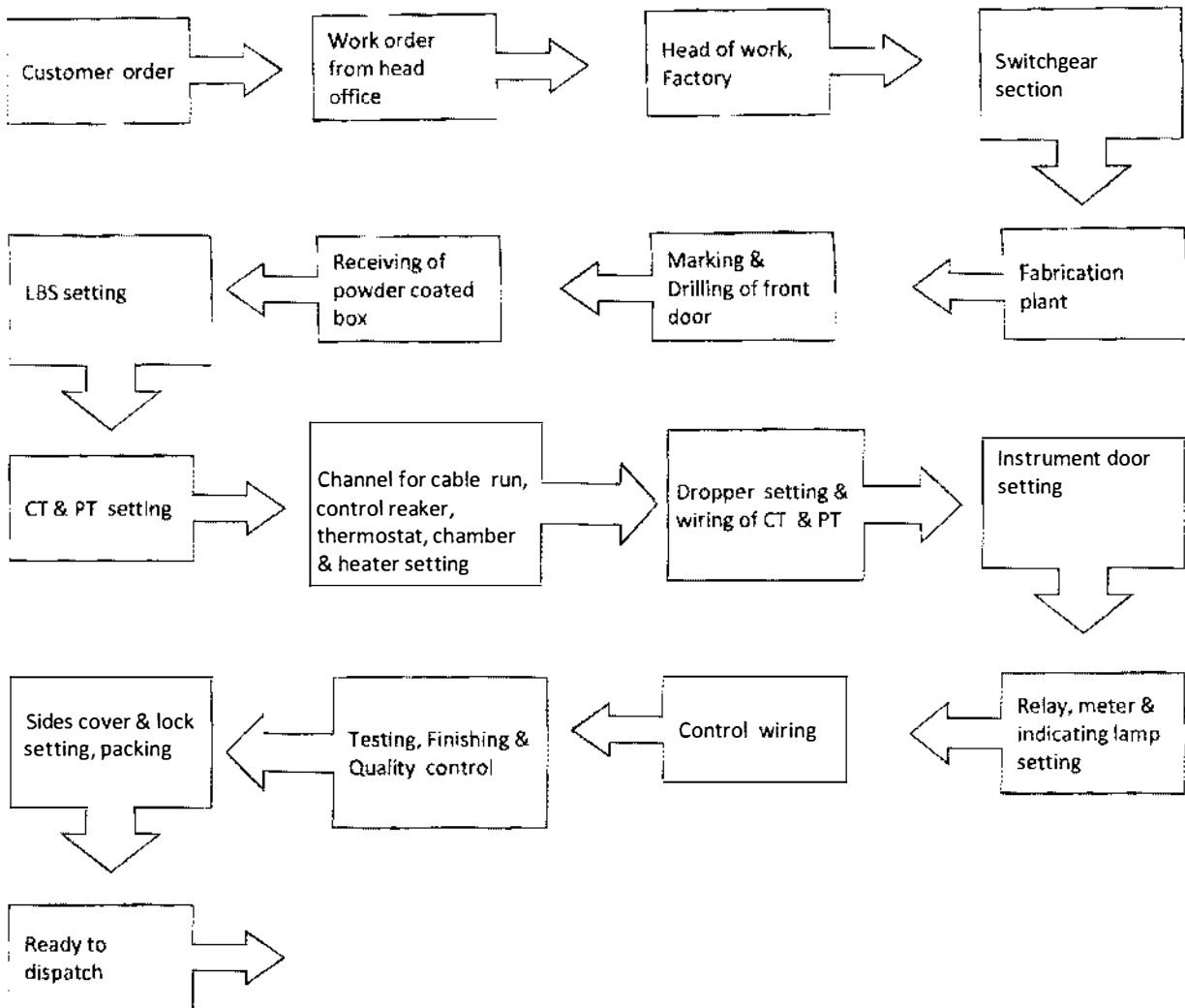

Figure 0-6: Process flow chart of HT load break switch

4.6.LT switchgear

LT switchgear is used for power control and distribution. The rated voltage is up to 415V (Phase to Phase) and 220 V (Phase to Neutral). LT Panel switchboards are well steel sheet fabricated, fully enclosed, floor mounting, vermin and dust proof. LT switchgear can operate both manually and automatically (motor controlled).



Figure -: A screenshot of LT switchgear manufactured at Energypac

LT panel ammeter measures current with the help of CT from the main bus bar. Ring CT is used in LT switchgear to measure current as ammeter cannot measure more than 5A current. Voltmeter is connected directly with the line in case of LT panel. Spring charged motor controlled MCB is used in LT panel. A control switch is used for the protection of MCB. For three phase current display, there are three ammeters. To monitor voltage and current, voltmeter, ammeter, indicating lamps, selector switch etc. are mounted on the upper portion of the front cover of the LT panel Box. Copper bus bars of adequate size with Red, Yellow & Blue marking are accumulated on the back upper portion of the Box. The bus bars are strongly supported by insulators having adequate mechanical and electrical strength.

4.6.1. LT switchgear vital components

The LT switchgear consists of different components. Some vital components are stated in below.

- Air Circuit Breaker (ACB)
- Molded Case Circuit Breaker
- Miniature Circuit Breaker (MCB)
- HRC Fuse
- Ring CT
- Relay
- Bus Bar
- Ammeter

4.6.2 Process flow chart of LT switch gear

The production process of LT switchgear consists of different phases. The LT switchgear is mainly assembled at the switchgear section of Energypac. The production process steps of LT switchgear are shown in below as a form of flow chart.

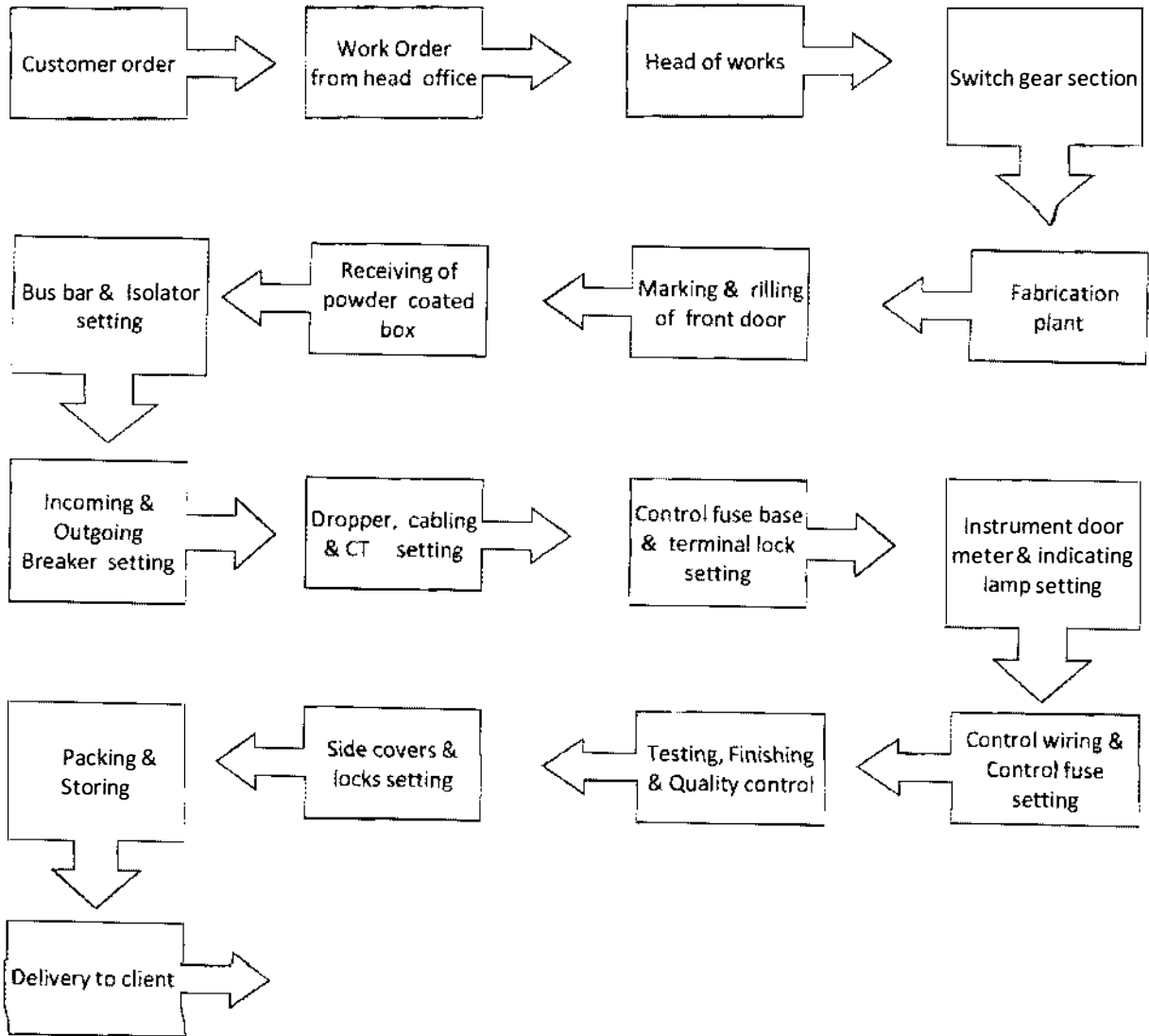

Figure 0-8: Process flow chart of LT switchgear

4.7. Power Factor Improvement (PFI) Plant

PFI plant is capable of controlling all forms of power factor correction by capacitor banks from small unit to a large plant. Most of the loads are inductive with lagging power factor so by adding capacitor bank in the form of PFI plant the power factor improvement is done.

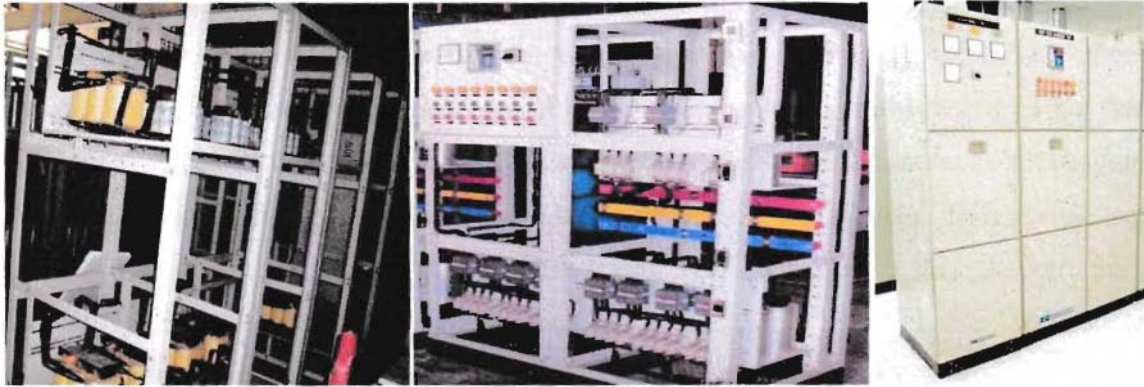

Figure :- PFI panel with Harmonic Filter Reactor; Capacitor bank; Front view

4.7.1. PFI panel vital components

The PFI panel consists of different components. Some vital components are stated in below.

- Power factor correction relay
- Miniature Circuit Breaker (MCB)
- Capacitor bank
- HRC fuse
- Bus Bar
- Magnetic Contactor
- Magnetic coil
- CT
- PT
- Wattmeter
- Indicator flags

This chapter gives a brief idea about the devices manufactured at the switchgear section of Energypac Engineering Ltd. The production process of vacuum circuit breaker, and the in process tests like endurance test, megger test, HV test, analyzer test, contact resistance test conducted for vacuum circuit breaker is discussed in this chapter. The production process of load break switch, LT switchgear, power factor improvement panel, the name of some vital components is discussed in this chapter. The switchgear section mainly deals with the assembling of the above stated switchgear elements.

Chapter 05

INSTRUMENT TRANSFORMER

I worked at Instrument transformer section for two consecutive days (May 11, 2011 & May 12, 2011), under the supervision of Engr. Mozaharul Islam & Engr. Faisal. In this section I got familiar with different types of instrumental transformer and their manufacturing process. This chapter will deal with the manufacturing steps involved with instrumental transformer. Some vital process associated with instrumental transformer manufacturing will be added in this chapter. Some in process test; routine test will also be integrated in this chapter. This chapter will contain a comprehensive idea regarding the manufacturing of instrument transformer from the raw material to a complete transformer.

5.1 Introduction to Instrument Transformer

Instrument transformers transform voltage or current from the high values in the transmission and distribution systems to the low values that can be utilized by low voltage metering devices. An instrument transformer's role is to provide accurate inputs to protection, control and metering systems. At Energypac almost all parts of instrumental transformer are made from their raw material and after manufacturing some in process tests are done and then supplied to the client.

5.2 Types of Instrument Transformer

According to the operation performed by instrumental transformer they are divided into two types.

- Current Transformer (CT)
- Potential transformer (PT)

According to the using condition of instrumental transformer they are divided into two types.

- Indoor type
- Outdoor type

Undergraduate Internship Report

5.2.1. Current Transformer

Current Transformers are designed to produce a scaled down replica of the current in the power line and isolate the measuring instruments, meters, relays, etc. from the high voltage power circuit. Current Transformer is used to measure the amount of current in a line by a predefined CT ratio.

5.2.2. Potential Transformer

Potential transformer is used to measure the amount of voltage in a line. It protects the transformer by dropping the voltage of the line according to the PT ratio. It is also used to measure the amount of power transmitted through the line.

5.3. Application of instrument transformer

The instrumental transformer is used in different application. Instrument transformers are ideally suited in the following applications:

- Indoor
- Switchgear assemblies
- Motor controllers
- Over power transformer bushings
- Over circuit breaker bushings
- Metering
- Relaying
- Current sensing

5.4.Types of Products

Four different types of CT & PT are manufactured under the hood of instrument transformer section at the factory of Energypac Engineering Ltd.

- Outdoor type (Oil cooled) CT up to 230 KV
- Outdoor type (Oil cooled) PT up to 230 KV
- Indoor type (Dry) resin cast CT up to 11 KV
- Indoor type (Dry) resin cast PT up to 11 KV

Undergraduate Internship Report

5.5. Indoor (Dry) type CT / PT

Indoor (dry) type transformer's core and winding get covered with epoxy resin. The epoxy resin keeps the windings safe from dirt and unsafe condition. The transformers are dry, no cooling oil is used.

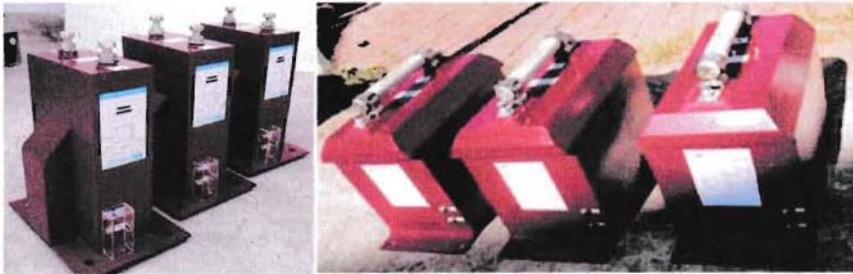

Figure -: Indoor type resin cast CT & PT manufactured at Energypac

5.5.1. Chemical used for cast resin CT / PT

Some chemical are used for manufacturing of cast resin CT / PT. the ration of the chemical used need to be accurate as per regulation. Otherwise the quality of the cast resin CT / PT can be hampered. In below a list for 1 set C.T (3 Nos Metering: 30 / 5 A to 200 / 5A) is stated.

Hardener	HY 905	:	3.6 kg
Araldite	CY 205	:	3.6 kg
Accelerator	DY 061	:	0.018 kg
Plasticizer	DY 040	:	0.36 kg
Silica Filter		:	14.4 kg
Dobefil Brown		:	0.1 kg

5.5.2. Manufacturing process flow chart of indoor type CT / PT

The production process of indoor type CT / PT is divided into different phases. The phases are related to one another. After the completion of one phase the next phase starts. The entire manufacturing process is shown at below as a form of process flow chart.

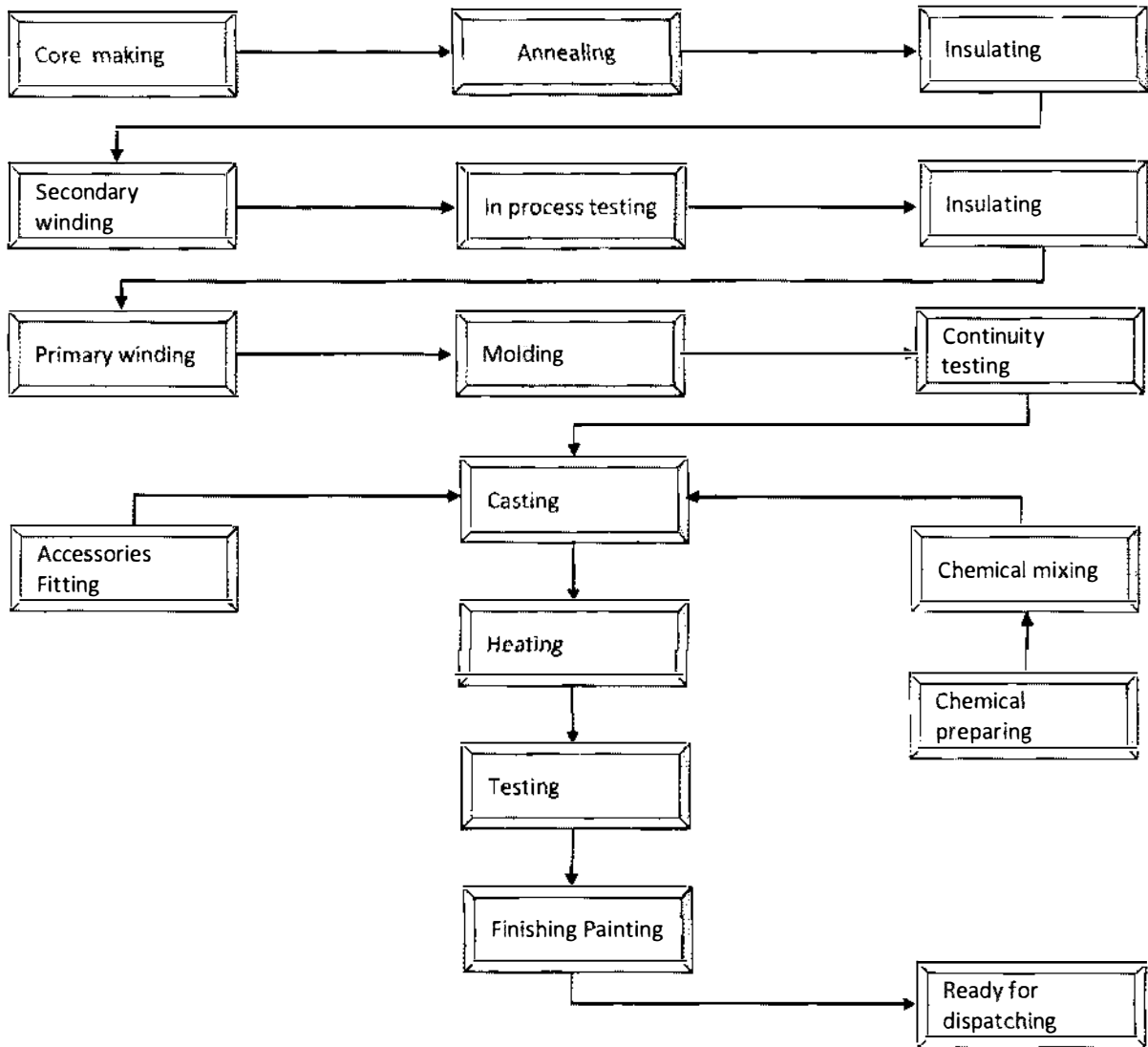

Figure -: Manufacturing process flow chart of indoor type CT or PT

Undergraduate Internship Report

5.5.3. Process description

The manufacturing process stated above in the flow chart is briefly described in below.

Core: First core of silicon still is cut according to required diameter.

Annealing: Here, Core is heated in annealing chamber at 800 °C for 72 hours.

Insulation: After taken out from annealing chamber, the core is cooled. After that, insulation is done by wrapping it with insulating paper.

Secondary turn: After the insulation process completion, the secondary winding is given with the help of winding machine. For secondary winding Super Annam 36 no wire is used.

In Process Testing: In process testing is done for determining primary turn.

Insulation: After testing insulation is given by wrapping with insulating paper.

Primary turn: After the insulation process completion, the primary winding is given manually.



Figure -: Core coil assembly for indoor type CT

Undergraduate Internship Report

Molding: It is kept on a mold and then prepared for chemical mixing.



Figure -: Preparing for molding for indoor type CT

Continuity Testing: Continuity test is done with the help of a multimeter.

Chemical Mixing & Casting: Mold is placed in a pouring chamber which is fully vacuumed. Chemical mixing is done at mixture chamber at 80 °C. The pouring takes almost 15 to 20 minutes to be completed.

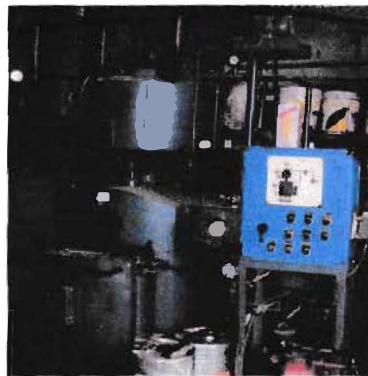

Figure -: Pouring and mixing chamber for indoor type CT / PT

Heating: After chemical mixing it is placed into the heating chamber. Heating is done for 20 hours at 100°C temperature. Then the final product is produced.

Undergraduate Internship Report

5.6. Oil type PT

Oil type PTs are named because of their cooling process. Oil is used as coolant for this type of PTs. Where the heat generation is higher than as a PT, oil type PT is used.

5.6.1. Main parts

An oil type PT consists of different parts. Among them some vital components are listed below.

- Core
- HT coil
- LT coil
- Tank

5.6.2. Process of manufacturing

1. Core making

Here the core is cut manually. Then the core is decorated as the designed order.



Figure --: An example of Core used for oil type PT

2. HT Coil making:

At first around the winding paper the HT super anam 36 coils are surrounded by the certain design model with the help of automatic winding machine.

Then the paper is cut down and the heavy part is made. A copper pipe is used for the support of the perpendicular part of the above heavy part.

The HT coil finish (used later as HT connection) is taken out inside the supporting part. A 5 mm insulation board paper is used inside the copper pipe. Then inside the copper pipe the HT line out is taken out. (Only one line is taken out for PT).

Undergraduate Internship Report

Over the copper pipe a black sheet is used for surrounding the copper pipe. Over that the high voltage tape is used for surrounding. Over that a cotton tape is used. Then again another part is starts with the same process.



Figure -: An example of HT coil of oil type PT

3. LT coil making:

Spiral HT coil made by bare conductor or desire coil ordered by customer is taken from the coil winding division for the use of LT coil.

4. Core coil assembly

At this stage the HT coil, LT coil and the core is assembled. Then the top yoke of the core is filled. Necessary insulation is given with high voltage tape.

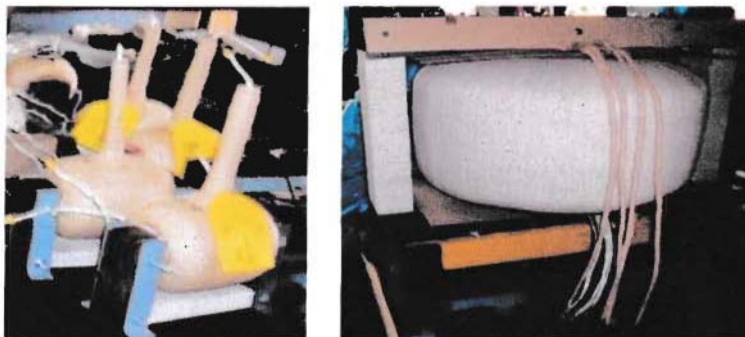

Figure -: Examples of oil type PT after core coil assembly

Undergraduate Internship Report

5. Tanking:

After the completion of core coil assembly the whole part is taken with overhead crane for tanking. A picture of a bottom tank (figure 5-9) is given in below. Here the connections are given carefully.



Figure -: An example of PT bottom tank for oil type PT

After tanking the PT is taken to the vacuum drying plant to be ensured that the PT is completely free of water vapor.



Figure -: An example of oil type PT

After completing the vacuum process the PT is taken for oil filling and after that it is taken for routine testing.

5.7. Oil type CT

Oil type CTs are named because of their cooling process. Oil is used as coolant for this type of CTs.

5.7.1. Process of manufacturing

At first a round core is prepared. Then the core is surrounded by the high voltage tape.



Figure -: A screenshot of Core used for oil type CT / PT

Then using auto machine the LT coil is prepared

The LT coil is of two types:

- Metering coil
- Protection coil

According to the customer demand the number of metering coil, protection coil varies. The number of turns also varies. Then the metering coil and protection coil (always 1 protection coil) is covered with the high voltage tape.



Figure -: Protection coil; metering coil

Then using the insulation paper and high voltage paper and cotton tape the heavy part is constructed the upper perpendicular side is as same as PT.

Undergraduate Internship Report

The heavy part with the perpendicular part is used as secondary. The primary tape is just surrounded by hand and two terminal P1 & P2 is taken out.

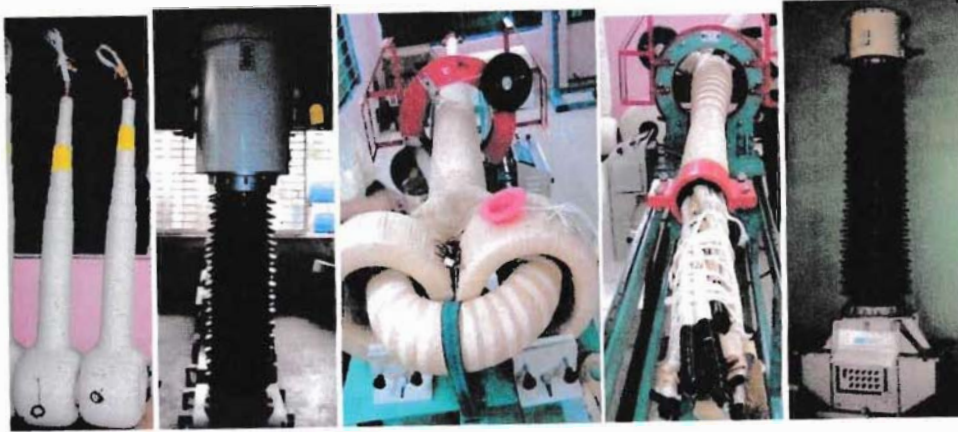

Figure -: CT at different stages

5.8. Ring Type CT

Only secondary coil like a ring is manufactured. Primary coil is taken inside the ring type CT. These types of CTs are mostly used for metering purpose. Generally the secondary coil is made using the auto coil winding machine. After that insulation is given using the high voltage tape.

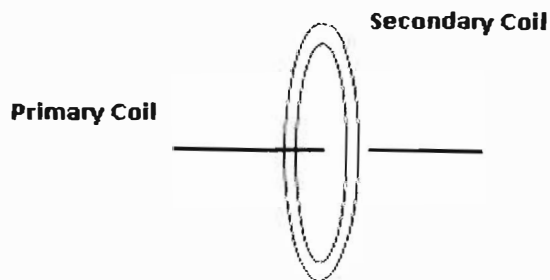

Figure -: Geometric view of a ring type CT

Undergraduate Internship Report

5.9. Nameplate of a CT

A nameplate of a current transformer gives almost all necessary information about the transformer. An example is given below.

Nameplate

Current Transformer

Rated voltage	-	33 KV
Insulation Level	-	70 / 170 KV
Rated S.T.C. (3 sec)	-	25 KA
Construction	-	Outdoor
Rated Thermal Current	-	120 % IP
Ratio	-	800 / 5-5A
Rated Sec. Burden	-	25VA
Highest System Voltage	-	36 KV
Rated Frequency	-	50 Hz
Type	-	LIVE Tank
No of Phase	-	Single
Total Weight	-	90 kgs (Approx)
Application	-	Metering / Protection
Class of Accuracy	-	0.2 / 5P20
Year of Manufacturing	-	2011

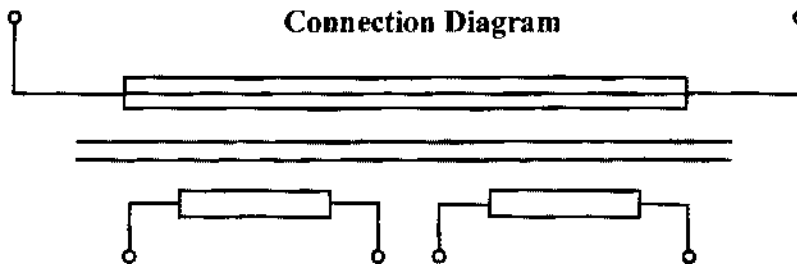

Primary Connection	Ratio	Secondary Connection	
		Metering	Protection
$P_1 - P_2$	800 / 5 A	$1S_1 - 1S_2$	$2S_1 - 2S_2$

Undergraduate Internship Report

5.10. Testing

Like power and distribution transformer instrumental transformers are taken under routine, type & especial test too.

5.10.1. Routine tests

The routine test is conducted by the Energypac for instrument transformer is listed below. These tests are done after the completion of the job to check whether the completed job is ok or not.

- Verification of terminal marking
- Power frequency withstand test on primary winding
- Partial discharge measurement
- Power frequency withstand test on secondary winding
- Power frequency withstand test between section
- Enter turn over voltage test
- Determination of errors

5.10.2. Special Test

The special test is conducted by the Energypac for instrument transformer is listed below. These tests are done after the completion of the job to check some certain properties of the transformer.

- Chopped lightning impulse test
- Measurement of capacitance and dielectric dissipation factor test
- Mechanical test

5.10.3. Types test

The type test is conducted by the Energypac for instrument transformer is listed below. These tests are done after a long time for a single product from a lot to determine the design of the transformer.

- Short time current test
- Temperature rise test

Undergraduate Internship Report

The chapter gives a brief idea about the manufacturing process involved with instrumental transformer at the factory of Energypac Engineering Ltd. Different important process related to both oil type and dry type current transformer and potential transformer manufacturing is discussed in this chapter. It consists of the manufacturing processes of dry type current transformer and potential transformer started from the raw material preparation. Some tests including in process test, routine test observed by me at the factory of Energypac Engineering Ltd are included in this chapter. To sum up; this chapter includes an inclusive idea about how an instrument transformer is manufactured from the raw material to a complete transformer.



Chapter 6

ISOLATOR AND SWITCH

I worked at isolator & switch section on May 14, 2011 under the supervision of Engr. Ataul Goni. At the starting of the day, I was given some ideas about isolator & switches manufactured at Energypac and the construction of isolator & some tests of isolator. Here I get familiar with different types of isolators and their assembling process. This chapter will provide a clear concept about the manufacturing process of isolator. Three types of isolators single break isolator, double break isolator and central break isolator are mainly assembled here. The vital parts and raw materials and important process associated with isolator assembling is included in this chapter.

6.1 Introduction to Isolator and Switch

In case of any fault occurred in the supply line, isolator & switch are used to save the transformer or other important electrical device and recovering the fault. Actually these are used to connect and disconnect the supply line in various purposes. Isolator connect or disconnect three phase with single connector (Gang operation), but switches connect or disconnect each single phase with individual connector.

6.2 Types of Isolator

Isolator is primarily used for maintenance purpose. Mainly two types of isolator are manufactured at Energypac Engineering Ltd.

1. Outdoor type

- Manually operated:
 - 11 KV Isolator
 - 33 KV Isolator
- Motor operated:
 - 132 KV Isolator

Undergraduate Internship Report

2. Indoor type

- Manually operated:
 - 11 KV Isolator

According to the breaking system of isolator, isolators are again divided into three types.

- Single break isolator
- Double break isolator
- Central break isolator

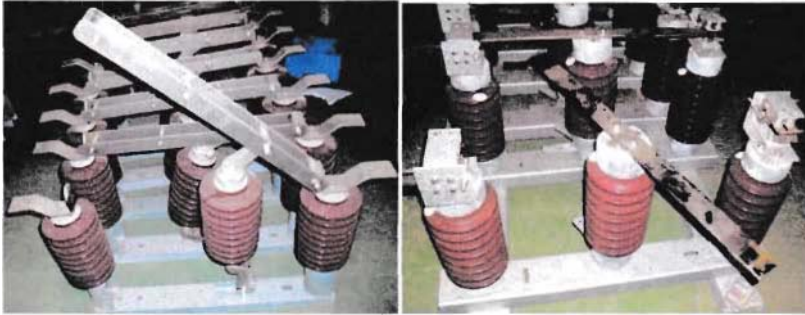

Figure -: Single break isolator ; Double break isolator

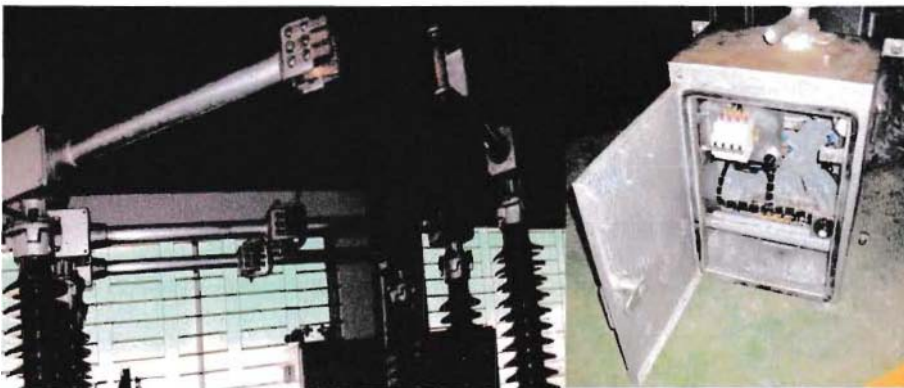

Figure -: Central break isolator and its driving box

Undergraduate Internship Report

6.2.1. Main parts of an ideal Isolator

An isolator is a combination of different parts. The name of some main parts of an isolator is listed below.

- Base channel
- Insulator support
- Insulator
- Top & bottom insulator support
- Fixed & moving contact
- Fixed support contact
- Operating box
- Connector
- Flexible braded tape
- Pipe
- Spilt pin
- MS square bar
- SS hallow square bar
- Auxiliary

6.2.2. Raw Materials for Isolator

To manufacture an isolator various raw material is needed. The name of some important raw materials of an isolator is listed below.

- MS sheet
- PORCELAIN insulator
- Gun metal
- Copper bar
- Nut + Bolt (SS)
- Aluminium casting

6.2.3. Operation Performed

To manufacture an isolator different operations are performed in the isolator section. The name of some operation performed under the isolator section is given below.

- Cutting
- Drilling
- Slotting
- Grinding
- Threading
- Grooving
- Chambering

Undergraduate Internship Report

6.2.4. Machine used

To manufacture an isolator different machines are used for various operations in the isolator section. The name of some machine used under the isolator section is given below.

- Lath Machine
- Milling Machine
- Drill Machine

6.2.5. Process flow chart of 33 kv fused isolator, 100/200A

The production process of an isolator is divided into some phases. The production phases are expressed as a form of work process flow chart stated below.

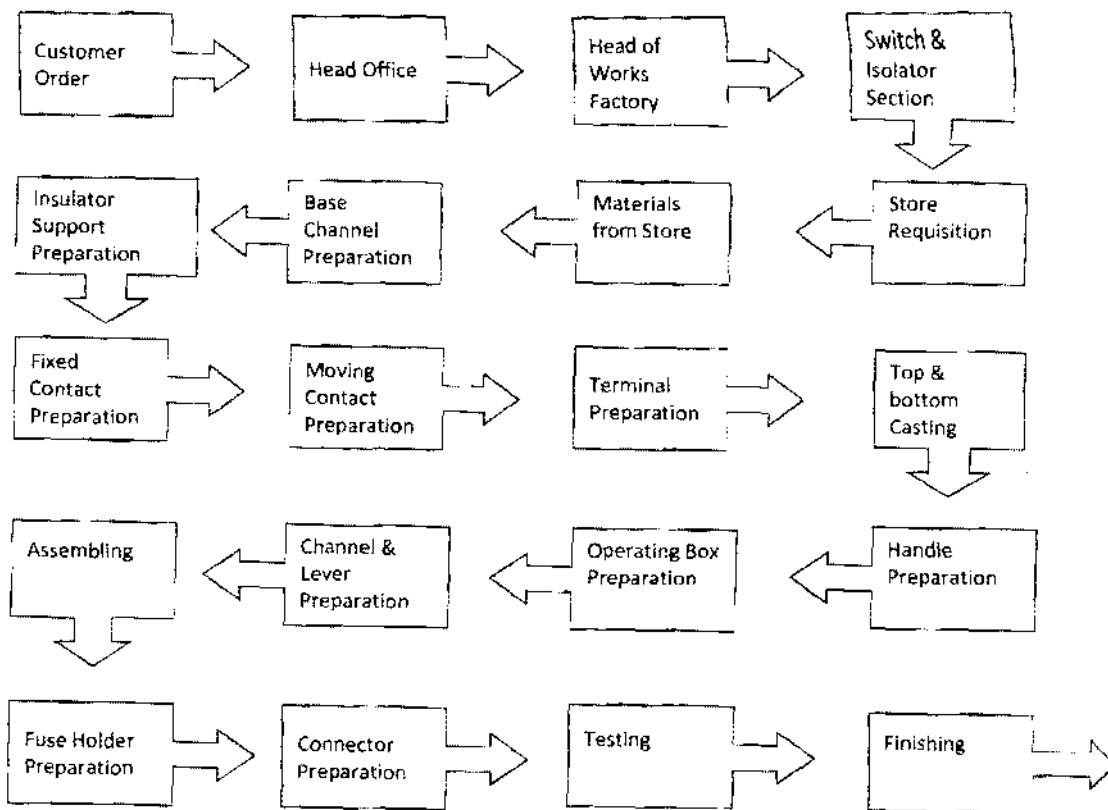

Figure -: Process flow chart of an isolator

Undergraduate Internship Report

6.2.6. Nameplate of an Isolator

The nameplate of an isolator contains some basic information about the isolator. An example of the nameplate of an isolator is given below.

ISOLATOR		
STANDARD		IEC - 129
TYPE		ECB - 33
RATED VOLTAGE	KV	33
RATED CURRENT	A	1250
BASIC INSULATION LEVEL	KV	170
STC (FOR 3 SEC)	KA	25
RATED AUXILIARY VOLTAGE	V	110
YEAR OF MANUFACTURE		2011
SERIAL NO		38

6.2.7. Tests for Isolator

To test a complete job's condition Energypac has a system of taking the job under some tests. These tests are done to ensure the quality of product. Some common test done under the hood of isolator section is given below.

- Contact Resistance test
- Insulation test
- Power frequency withstand test (High Voltage test)
- Mechanical operation test.

Undergraduate Internship Report

6.3.Switches

Switches (figure – 6.3) are mainly used for switching purpose. Some switches manufactured at the factory are listed below.

- 34.5 KV, 600 A, Air breaker switch with load interrupter
- 34.5 KV, 600A, Disconnecting switch
- 34.5 KV Drop out fuse holder
- 15.5 KV, 600 A, Auto voltage regulators switch (AVR)
- 15.5 KV, 600 A, Auto circuit re-closer switch (ACR)
- 15.0 KV Disconnecting switch
- 15.0 KV Voltage regulator switch
- 15.0 KV, 400 A, Regulator by Pass switch



Figure -: A snapshot of switches displayed at Energypac

The chapter gives a brief idea about the production process of isolator at Energypac Engineering Ltd. At Energypac, under the hood of isolator section mainly the three types of isolators single break isolator, double break isolator and central break isolator are assembled. The vital parts and raw materials needed for an isolator is discussed in the chapter. Different important process related to isolator assembling is discussed in this chapter. Types of isolators manufactured at Energypac are also mentioned. Some tests done for the isolator are also included in this chapter.

Chapter 7

FABRICATION SECTION

It was the last day of my internship at 'Energypac Engineering Ltd'. At first I met with Engr. Azimussan Abbasi. He gave me a brief idea about fabrication section and about their working method under the section. Then I visited the fabrication section with him. This chapter will present a clear concept associated with the fabrication section of the factory of Energypac Engineering Ltd. The working technique and procedure carried out in this section with the working theory and operations of some machines will be mainly focused in this chapter.

7.1 Introduction to Fabrication Section

Fabrication is the process of fabricating a structure. In this section transformer tanks, CT&PT tanks, radiator tanks, switch gear boxes, VCB boxes are fabricated. It is an important section of the factory.

7.2 Types of Product

Different parts of different products are manufactured under the hood of fabrication section. The name of some vital products is given below.

- Transformer tanks
- CT&PT tanks
- Radiator tanks
- Switch gear boxes
- VCB boxes

7.3 Operations Performed

To manufacture different kinds of products various operations is done under fabrication section. The name of some vital operations is given below.

Undergraduate Internship Report

✚ Cutting:

- Gas cutting
- Plasma cutting

✚ Grinding

- Welding:
 - Electric arc welding
 - Seam welding
 - Spot welding
 - Stud welding
 - Projection welding
 - MIG welding
 - Die punching
 - Forming
 - Bending
 - Shearing



7.4. Machine Used

To manufacture different kinds of products various machine is used in fabrication section. The names of the machines are given below.

- NC hydraulic press machine
- Power press machine
- Hydraulic shearing machine
- Power bending machine
- Forming machine
- Hydraulic swing beam shear
- Power shearing machine
- Spot welding machine
- Seam welding machine
- Knurling machine
- Gas cutting machine
- Plasma cutting machine
- Electric arc welding machine
- MIG welding machine
- Stud welding machine
- Grinding machine

Undergraduate Internship Report

7.5. Operations of Machines

Different operations are used for different purposes. Operations of machines are discussed in brief in this section.

7.5.1. Hydraulic shear machine

Operations:

According to the required thickness the blade is adjusted by blade setting knob and the cutting length is adjusted by switch box. Finally the job (sheet) is placed on the machine bed and cutting is done by foot switch.

7.5.2. Hydraulic Bending Machine

Operations:

According to the job requirement, blade is adjusted to the hydraulic shaft. For corresponding job, die is set on bed. Operating the tool switch the job is done.

7.5.3. Power Bending Machine

Operations:

The required angle is set by angle setting knob. Die is set on the bed. According to required size of job, gage is set by gage setting then the job is held on the die. Operating the foot switch the job is done.

7.5.4. Forming Machine

Operations:

The job is pushed to roller arrangement for forming.

Undergraduate Internship Report

7.5.5. Power Press Machine

Operations:

Required job punch is set to the connecting rod and die is set on bed. Then the job is hold on the die. Operating the foot switch the job is completed.

7.5.6. Seam welding Machine

Operations:

The operation of seam welding is divided in two ways (i) Spot welding; (ii) Resistance welding.

Spot Welding:

The job is arranged on down ward wheel. At a time the foot switch is on and the up ward wheel press the job. The welding is done in a discontinuous manner.

Resistance Welding:

In resistance welding the foot switch is on and the job is continuously welded.

7.5.7. Knurling Machine

Operations:

The motor is started. Then the job is push to roller arrangement for forming.

7.5.8. Electric Arc Welding Machine

Operations:

The electrode is set up on holder according to job thickness. Then the neutral line is put on the job and the welding is started.

Undergraduate Internship Report

7.5.9. MIG Welding Machine

Operations:

The control switches on the copper wire flow through the pipe, with the help of motor and CO₂ gas. Then the holder switch is pressed and by sparking copper is melted. At that time high temperature rise and this temperature melt the adjoining parts and welding is done.

7.5.10. Radial Column Drill Machine

Operations:

Drill bit is set in the spindle by the help of chuck key according to hole. Then the feed holder is set according to a hole depth. Then the job is set on table. The power is on and the operation is completed to job.

7.5.11. N.C Hydraulic Press Break Machine

Operations:

According to the job requirement, bleed is adjusted to the hydraulic shaft. For corresponding job, die is set on bed. Operating tool switch the job is done.

7.5.12. C Hydraulic Shear Machine

According to our required thickness the bleed is adjusted by bleed setting nob and the cutting length is adjusted by switch box. Finally the job (sheet) is placed on the machine bed and cutting is done by foot switch.

7.5.13. Gas Cutting Machine

Gas cutting is the form of metal cuttings by using temperature and pressure of gas for above 6mm thickness of plate. There are two cylinders. One is of O₂ and another is of C₂H₂. Red color pipe indicate C₂H₂ and black color pipe indicate O₂. These gases are mixed at a ratio of 1:3.

Undergraduate Internship Report

Operations:

At first oxygen and acetylene pressure is adjusted. Then nozzle is setup in the head of touch according to plate thickness.

Plate Thickness	Nozzle Size
3-6mm	1/32"
7-12mm	3/64"
15-50mm	1/16"

Then these two gas valve is on and these gases mixed in holder. As the gases flow out through the nozzle head, by external source it is fired. By adjusting the knob the required flame is set. The red color flame is C_2H_2 and blue color flame is O_2 .

7.5.14. Plasma Cutting Machine

Plasma cutting is the special form of metal cutting by using air pressure and electricity. Plate thickness above 6mm is cut by plasma or gas cutting. If gas cutting tool is damages or gas ($O_2+C_2H_2$) are not available, then as alternate cutting purpose, plasma cutting is done.

Operations:

It needs higher electric power. When the holder is pressed electricity flow through the pipe and high air pressure also flow from air cylinder. This electricity produce spark at nozzle head and high temperature. These high temperatures melt the metal and high air pressure cut the metal.

Undergraduate Internship Report

7.6. Testing

Different tests are done under the fabrication section to verify the fabricated products quality.

Among them some vital test are described in below.

7.6.1. Radiator Testing:

The radiator testing is used to find out any leakage in radiator. Some radiator is small and some radiators are large. According to size of radiator the testing pressure are varied. For small radiator testing pressure is 2.5kg/cm^2 and for large radiator testing pressure is 3kg/cm^2 and maximum testing pressure 32PSI. If any leakage is found then it is ready for repair arc welding.

7.6.2. Tank Testing:

For whole tank testing the tank is assembled with required nut-bolt arrangement. Then by an air compressor 1kg/cm^2 or 10 PSI pressure is given into the tank and set powder mixed with water is given in various joint and corner. If any leakage is present, bubble is formed in that position, then necessary action is taken and if the tank is fit for use in transformer no bubble is formed.

This chapter gives a concept of the fabrication section of the factory of Energypac Engineering Ltd. The working method and operation performed under the hood of fabrication section is mainly discussed in this section. In addition, the working principle and operations of some machines used in this section is also discussed in this section. Some tests done under this section like radiator testing, tank testing is also discussed in this chapter.

Chapter 8

POWDER COATING

It was the last day of my internship at 'Energypac Engineering Ltd'. I met with Engr. M.A. Wazed, who gave me a brief idea about powder coating section and working method under the section. Then I visited the section with him.

8.1 Introduction to Powder Coating Section

Powder coating section (figure - 8.1) is another important section in which job is coated by powder. Various parts of switch gear and VCB boxes are coated here. Powder coating is the process of coating a surface in which a powder material is applied using an electrostatic or compressed air method. Unlike liquid paint, no solvents are used in powder coating.



Figure 0-1: A snapshot of Powder Coating Section at EEL

8.2 Powder Coating Method

In Energypac Engineering Ltd. (EEL), Electrostatic powder coating method is used. Finely ground particles of pigment and resin are electrostatically charged and sprayed onto the products to be coated with the help of a spray gun. The applied powder is then heated (cured) to its

Undergraduate Internship Report

melting point, after which it flows to form a smooth film which dries to a firm, durable finish very resistant to scratches, cracking, peeling, UV rays and rust.

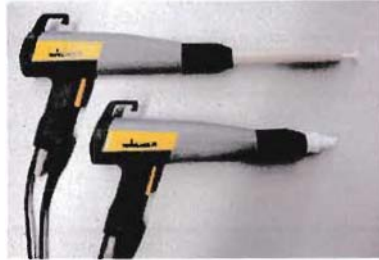

Figure -: An example of powder spray gun

8.3. Metal & Powder

Mild steel sheet up to 3.0 mm thickness is used for powder coating. An Unreformed polyester resin powder is used at Energypac for powder coating purpose.

8.4. Powder Types

Two types of powder are used at Energypac factory for the purpose of powder coating.

- Pure powder
- Epoxy powder

8.5. Surface Types

Two different types of surface is created after powder coating according to the necessity.

- Glaze surface
- Structure surface

8.6. Manufacturing Steps

At the powder coating section, the job is done in two steps. First step is preparing the elements for powder coating. Second step is powder coating over the desired metal sheet.

8.6.1. First Step: Preparing elements

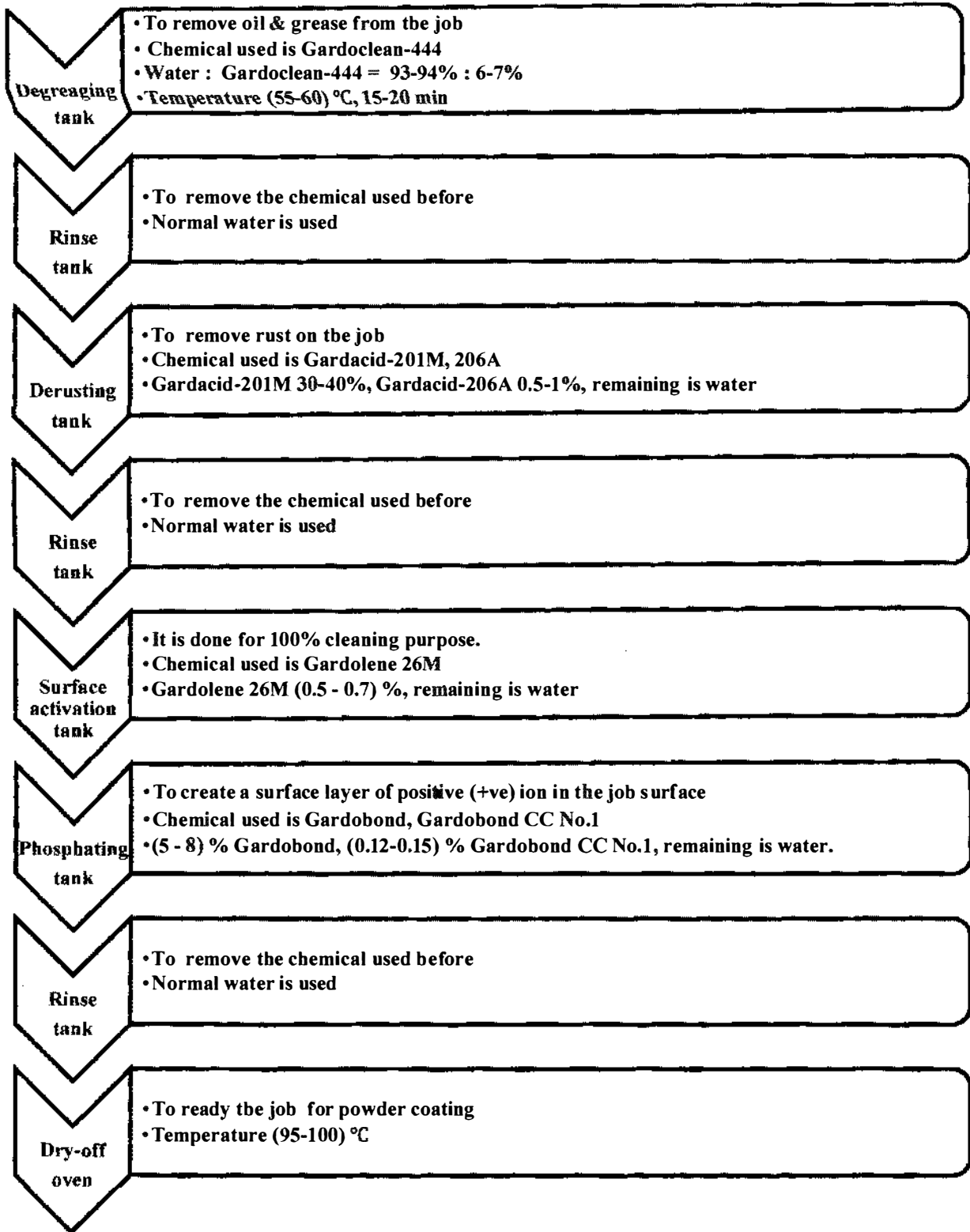

Figure -: First step of working procedure of preparing elements for powder coating

8.6.2. Second Step: Powder coating

The whole job of powder coating is done in two different phases. The first phase is done at powder coating booth. The second phase is done at curing oven.

Powder coating booth:

The job is loaded to a moving conveyer which moves 1m per minute. Then the job is passed through the powder coating booth (figure – 8.3) and using a spray gun (figure – 8.2) powder is sprayed on the job by Electrostatic method and then passed through the curing oven.



Figure -: A snapshot of powder coating booth at EEL

Curing oven:

In this oven temperature is maintained at 185-200°C. At this temperature powder melts and coating is done. The job takes 13 minutes to pass through this chamber.

8.7. Merits

Powder coating is good for any elements. Some merits of powder coating are discussed in below.

- Provide extra protection from ultra-violet rays, corrosion, abrasion & chemicals
- Durable, uniform and attractive finish
- Good electrical insulation properties

This chapter gives the information about the powder coating section of the factory of Energypac Engineering Ltd. The method powder used and surface made of powder coating is included here. Both the steps, preparing elements and powder coating are discussed with their process diagram in this chapter. The merits of powder coating are also mentioned in this chapter.

Chapter 9

LIQUID PAINT



It was the last day of my internship at 'Energypac Engineering Ltd'. I met with Engr. Azimussan Abbasi. He gave me a concise idea about liquid paint section and about the operational method under the section. Then I visited the section with him. This chapter will focus the working method of liquid paint sector of Energypac Engineering Ltd. The center of attention of this chapter will be the liquid painting procedure with their process diagram and duration

9.1 Introduction to Liquid Paint

Liquid Paint is anticorrosive. So it is used in order to protect the surface from corrosion. It increases longevity of the surfaces & makes it attractive.

9.2 Paint Types

Two different types of liquid paint is done under liquid paint section at Energypac.

- ❑ Normal paints
- ❑ Epoxy paints

9.3 Liquid Painting procedure

In liquid paint for both normal and epoxy paint the steps of painting are similar. The difference is in their raw material and time duration. Except that the paint procedure is almost same. A brief description of that procedure is given below.

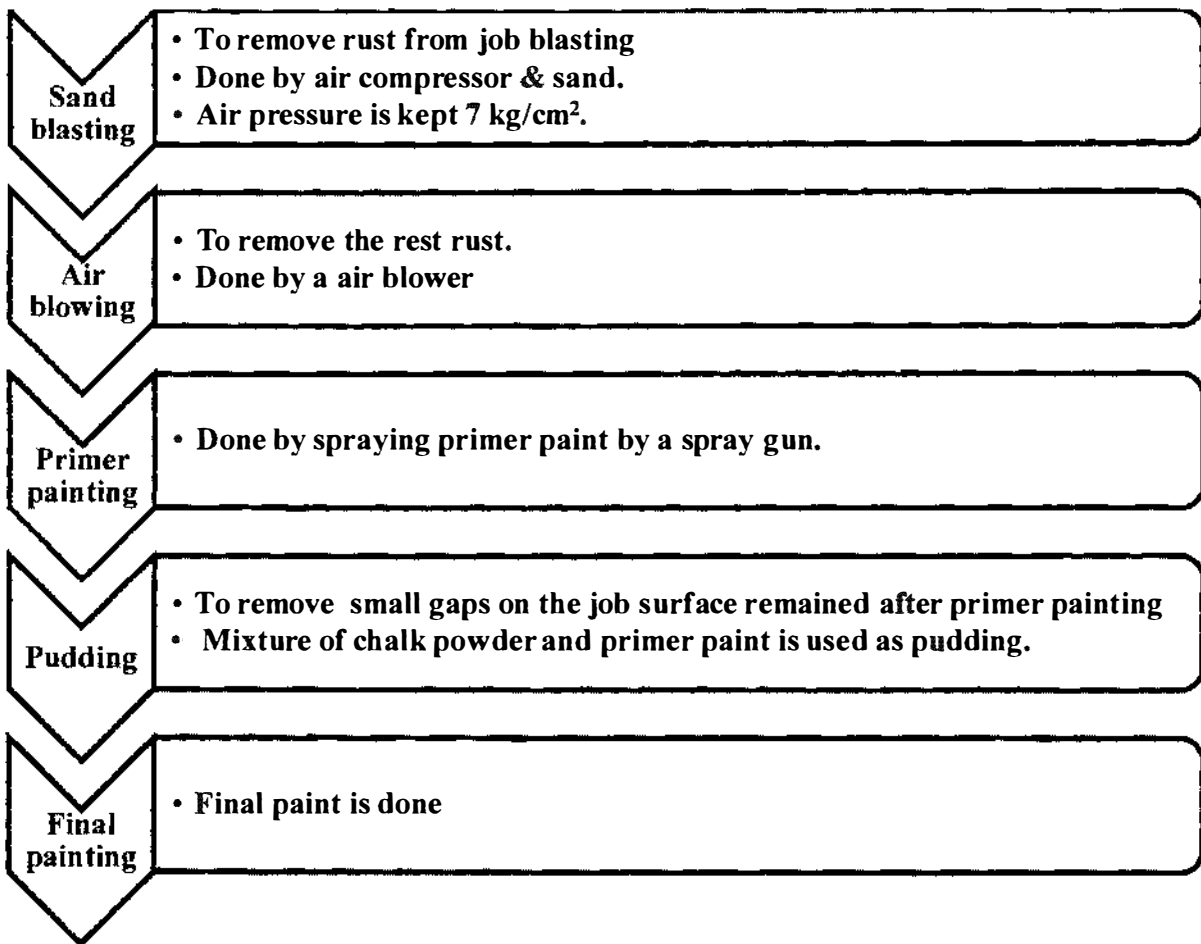

Figure -: Liquid painting working procedure

9.4. Normal Paint

Normal paint is done in two different phases. The first phase is called primer paint and the second phase is called final paint.

9.4.1. Primer Paint

Contents	:	Adzing phosphate primer, thinner.
Colour	:	Light grey
Mixture	:	Adzing phosphate primer: thinner = 4:1
Thinner used	:	T-6 thinner

Undergraduate Internship Report

9.4.2. Final Paint

Contents	:	Adzing phosphate enamel, thinner
Colour	:	Birch grey
Mixture	:	Adzing phosphate enamel: thinner = 4:1
Thinner used	:	T-6 thinner

9.4.3. Paint duration

Between every two steps of normal painting procedure some maximum duration is allocated & within this time the very next step need to be started.

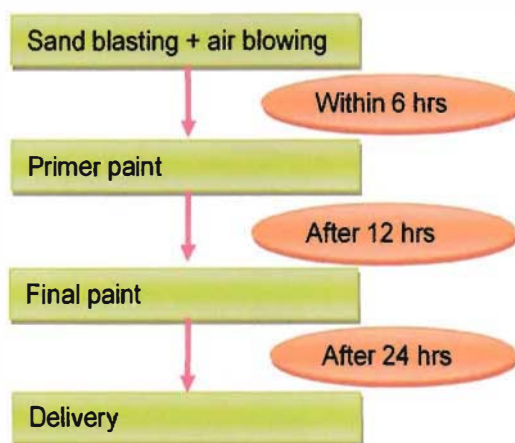

Figure -: Paint duration with the steps name for normal liquid paint

9.5.Epoxy Paint

Epoxy paint is also done in two different phases like normal paint. The first phase is called primer paint and the second phase is called final paint.

9.5.1. Primer paint

Contents	:	Epoxy primer, curing agent primer, thinner
Colour	:	Light grey
Mixture	:	Epoxy primer: curing agent primer: thinner = 2:1:1
Thinner used	:	T-7 thinner

Undergraduate Internship Report

9.5.2. Final Paint

Contents	:	Epoxy enamel, curing agent enamel, thinner
Colour	:	Birch grey
Mixture	:	Epoxy enamel
Thinner used	:	T-7 thinner

9.5.3. Paint duration

Between every two steps of painting procedure some maximum duration is allocated & within this time the very next step need to be started.



Figure -: Paint duration with the steps name for epoxy liquid paint

9.6. Merits

- Rework able
- Good-looking
- Comparatively lower cost than powder coating

This chapter signifies the liquid paint section of Energypac Engineering Ltd. It includes the working process of liquid paint section of Energypac Engineering Ltd. Liquid painting procedure with their process diagram and duration is also discussed in this chapter. The merits of liquid are also mentioned in this chapter.

Chapter 10

NICKEL COATING SECTION

It was the last day of my internship at 'Energypac Engineering Ltd'. I met with Engr. Azimussan Abbasi. He gave me a concise idea about nickel coating section and the operational method under the section. Then I visited the section with him. This chapter will integrate the nickel coating section of Energypac Engineering Ltd. It will focus about the working procedure of the nickel coating and the operation performed under the nickel coating section.

10.1 Introduction to Nickel Coating Section

Nickel coating is also an important section of *Energypac*. Due to the necessity of customer and job requirement some metals need to be nickel coated. In this section nickel coating, seven color, galvanizing, silver color etc. are done on various metals.

10.2 Operation Performed

Table 0-1: Operation performed under nickle coating section

Operation name	Metal name
Nickel coating	Brass & copper
Seven color	Mild steel
Galvanizing	Zn coating(mild steel)
Silver color	Copper, Aluminum etc.

10.3. Nickel Coating Procedure

The whole operation of Nickel coating is done in four several steps. The steps with their name and brief description are given below.

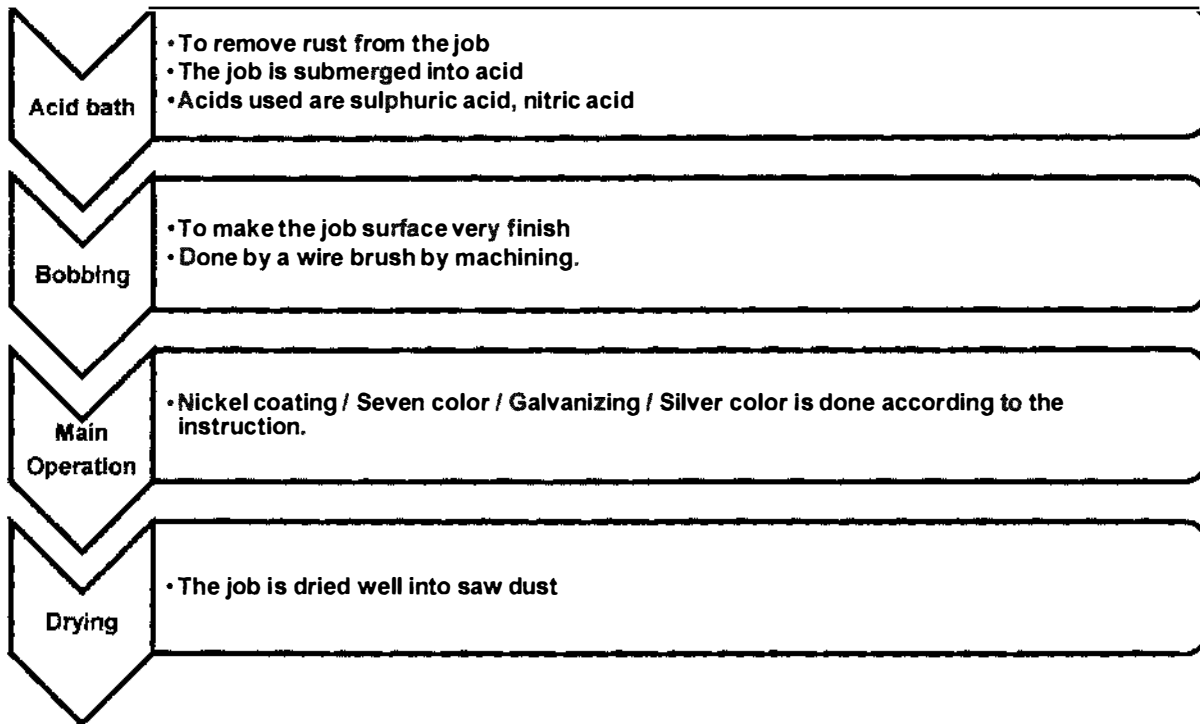

Figure -: Nickel coating procedure

10.4. Merits

Beautify, insulate, protect, and increase the corrosion resistance, conductivity solder ability of metal objects.

This chapter incorporates the nickel coating section of Energypac Engineering Ltd. It gives an idea about the work done under the nickel coating section at the factory of Energypac Engineering Ltd. The operation performed under this section, the procedure of nickel coating like acid bath, bobbing, main operation and drying is also discussed in this unit. The merits of nickel coating are also mentioned here.

Chapter 11

CNC SECTION

It was the last day of my internship at 'Energypac Engineering Ltd'. I met with Mr. N.M. Habibullah. He gave me a concise idea about CNC section and about the operational method under the section. Then I visited the section with him. The central point of attraction of this chapter will be the operational method of CNC section of Energypac Engineering Ltd. The program method diagram of CNC machine including the program load procedure and control system of the CNC machine will also be focused in this chapter.

11.1 Introduction to CNC Section

CNC means Computer Numerical Cutting. CNC machine is an auto machine which cuts the metal sheet automatically by the command of a computer program. The more information about the CNC machine is given below.

11.2 CNC program process diagram

The whole process done at CNC section is related to one another. With out completing one step another step can not be started. The steps are shown in below as a form of flow chart.

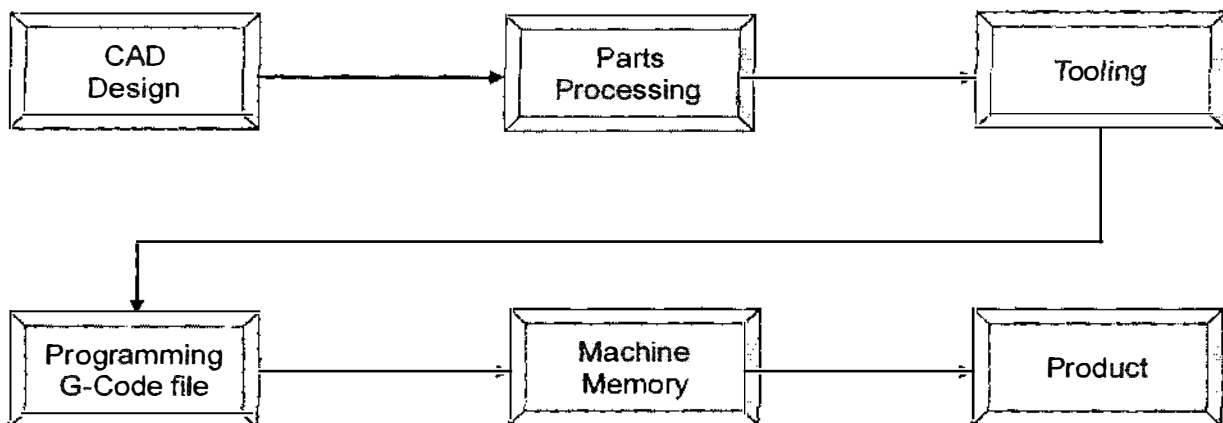

Figure 0-1: Program process diagram for CNC machine

Undergraduate Internship Report

11.3. Used Software

Common software used for CNC is:

- AP-100 Integrated CAD CAM
- FAST CAM
- SOFT SERVO

At Energypac the software AP-100 Integrated CAD CAM is used.

11.4. Program Load Procedure

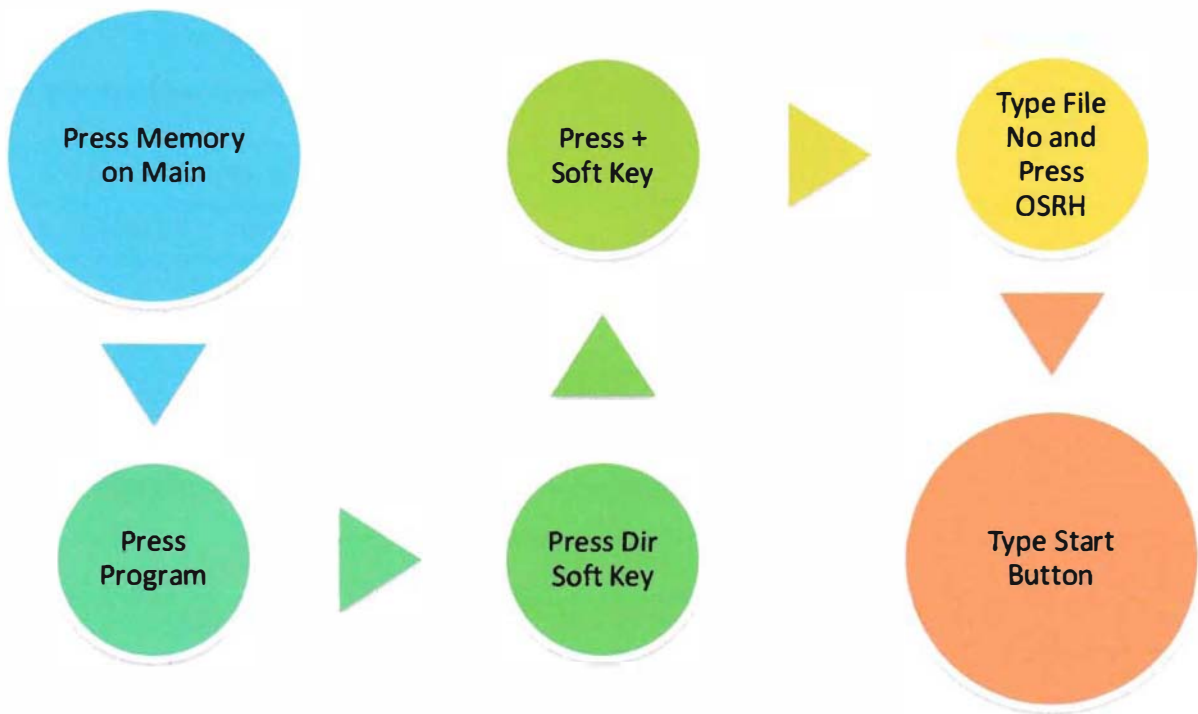

Figure -: Program load procedure for CNC procedure

11.5. Control System

Two types of control system are available at the CNC machine used at Energypac.

- Air system
- Hydraulic system

Undergraduate Internship Report

11.5.1. Air System

In air system air compressor is used. Required main air pressure is 0.49 MPa or (5.0 Kg / cm² or 72 psi). Required stricken blowing air pressure is same.

11.5.2. Hydraulic system

In hydraulic system oil is used. For hydraulic system, required main oil pressure is (20.10 ± 0.49) MPa or (205 ± 5 Kg / cm² or 2916 ± 71 psi).

Required pilot air pressure is (13.72 ± 0.40) MPa or (140 ± 5 Kg / cm² or 1992 ± 71 psi).

11.6. Section Arrangement

- 44-Station turret (for 30 series)
- 66-Station turret (for 30 series)
- 62-Station turret (for 50 series)
- 58-Station turret (for 30 series)

At Energypac, 58-Station turret (for 30 series) is used.

11.7. Required clearance for various metal sheets

Metal name	Clearance
MS	20-25% of the thickness of the sheet
Al	15-20% of the thickness of the sheet
SS	25-30% of the thickness of the sheet.

11.8. Minimum hole diameter

Metal	Minimum hole diameter
MS	1.0* t
Al	1.0*t
SS	2.0*t

Undergraduate Internship Report

11.9. Punching Capacity

$$P = \frac{A \times t \times \lambda}{1000}$$

Where,

P = Force required for punching in metric ton

A = length of the cutting edge in mm

t = thickness of the cutting sheet in mm

λ = shearing strength of work sheet.

*** If P does not exceed the Machine capacity, only then the work sheet is punched able.

This chapter includes the operational method of CNC section of Energypac Engineering Ltd. The program process diagram of CNC machine is discussed in this chapter. This chapter also includes the program load procedure and control system of the CNC machine. The punching ability of a CNC machine is also discussed in this chapter. To sum up, this chapter briefly integrates the CNC section and their performance.



Chapter 12

MACHINE SHOP

It was the last day of my internship at 'Energypac Engineering Ltd'. I met with Engr. Azimussan Abbasi. He gave me a concise idea about machine shop section and the operational method under the section. Then I visited the section with him. This unit will incorporate a brief idea about the machine shop section and the operation carried out under this section.

12.1 Introduction to Machine Shop

Machine shop section is also an essential section for the processing of various parts of different products. That's why; all sections of the factory are directly dependent on it. The machine shop is gathered with some modern machines which are capable of doing some extra ordinary work.

12.2 Types of Machine Used

Different types of machines are used in machine shop for various operations. The name of them with their available quantity in machine shop is given below.

<u>Machine Name</u>	<u>Number</u>
• Lathe machine	14
• Milling machine	02
• Drill machine	05
• Shaper machine	01
• Surface grinding machine	03
• Chaser machine	02
• Power saw machine	01
• Ball press machine	01
• Jig saw machine	01
• Grinding machine	02

Undergraduate Internship Report

12.3. Operation offered

As mentioned earlier, different types of machines are used in machine shop for different operational purpose. Some operations performed at machine shop with the name of associated machine are given underneath.

Table -: Operation offered at machine shop

SN	Operation	Machine
1.	Turning, facing, chambering, drilling, grooving, internal threading, external threading, cutting, boring.	Lathe Machine
2.	Surface finishing, slot cutting, gear cutting	Milling Machine
3.	External thread cutting	Chaser Machine
4.	Bending & punching	Ball Press Machine
5.	Cutting rod, pipe	Power Saw Machine
6.	Cutting plate, sheet	Jig Saw Machine
7.	Surface finishing	Grinding Machine
8.	Very smooth surface finishing of materials having	Surface Grinding Machine
9.	Drilling	Drill Machine

12.4. Types of Job Processed Here

At the machine shop of Energypac different parts of different jobs are processed. The name of job processed here with the name of main job is stated below.

12.4.1. CT-PT Tank

Some necessary components related to CT & PT tanks are manufactured here. The name of the products is given below.

- Ring
- Top - Bottom Cover
- Drain Valve
- Oil Bush
- Oil Cock
- Jaw Lock
- Pipe
- Pipe Bush
- Oil Level Plate
- Indicator

12.4.2 CT Finishing Task

Some necessary components needed for CT finishing task are manufactured here. The name of the products is given below.

- P1, P2 terminals
- Aluminium ring
- Teflon bush
- Aluminium flange
- Aluminium bushing clamp
- CT secondary flange

12.4.3 PT Finishing Task

Components required at the time of PT finishing task are manufactured here. The name of the products is given below.

- PT primary terminal
- PT primary terminal cap
- Bushing clamp
- Secondary terminal
- Primary terminal nut, core, bolt.

12.4.4 Casting CT-PT

Only one part required for casting CT & PT finishing is manufactured here. The product is:

- Brass hexagonal

12.4.5 Power & Distribution Transformer

Some necessary parts required for Power & Distribution Transformer are manufactured here. The name of the products is given below.

- Tie rod core bolt
- Suspension rod
- Pressure screw
- Core channel rod
- Pressure screw foot plate
- Flitch plate bush pressure ring
- Pressure screw cap
- Pressure screw cap top support
- Pressure screw cap bottom support
- LV & HV support
- LV & HV bushing
- LV & HV fittings

Undergraduate Internship Report

12.4.6 Switch Gear

Components required at the switchgear section are manufactured here. The name of the products is given below.

- Crain hook
- Security bolt
- Adjustable sheet
- Adjustable square

12.4.7 VCB

Some necessary parts required for vacuum circuit breaker are manufactured here. The name of the products is given below.

- Sutter bush
- Cable earthing bush
- Adjustable rod

This unit gives a brief idea about the machine shop section of Energypac Engineering Ltd and the operation performed under this section. Different necessary parts and trimmings needed for power, distribution & instrument transformer; different switchgear elements; vacuum circuit breaker is manufactured in this section. This unit also gives some idea about the operation offered for different job under this section.

Chapter 13

SAFETY MANAGEMENT

Safety is one of the most important concerns for the worker of a power equipment production factory. To ensure the safety of the worker of the factory every company should be concerned. Safety Management is the implementation of a "Safety Management System" into an organization. For safety management the commitment of the Energypac Engineering Ltd is "Safety First". Energypac Engineering Ltd has its own safety management system to ensure the safety of the worker of the factory.

13.1 Safety equipments provided

Energypac Engineering Ltd provides some safety equipment to their workers to ensure the safety at work place. Some of the major equipments are stated below.

- Safety shoes
- Safety goggles
- Hand gloves
- Safety apron
- Eye shield
- Ear plug
- Safety Musk
- Safety Helmet

13.2 Material Handling Equipments

Energypac Engineering Ltd has a large factory which handles different heavy materials due to their production purpose. To do so they need to use some material handling equipments. The name of some material handling equipments which are provided to the workers for handling over weight materials.

- Hand plat
- Overhead crane
- Fork left
- Chain wrist
- Boom truck
- Crane (50 ton & 35 ton)

13.3 Safety Equipments for Effective Fire System

Fire is also an important concern for a factory like Energypac Engineering Ltd. To avoid any unwanted situation related to fire the company has its own fire protective system. To use in case of fire emergency Energypac has some facility in every section.

- 3.0 kg Carbon dioxide gas
- 5.0 kg Carbon dioxide gas
- 21.0 kg Carbon dioxide gas

13.4 Some Findings about Safety

Energypac Engineering Ltd is concerned about the safety of the worker as well as factory. The factory provides safety equipments described above but most of the workers do not use all these equipments. In addition, some unwanted situation is also there in some section of the factory. Some of them are listed below.

- High voltage electrical wires are not kept safely in all section, in some place they are really in risky location, which can form a big accident at any time.
- All workers do not use safety shoes all time and No worker use safety helmet. The need to be more concerned about their safety.
- The office room at winding section is not safe, any metal elements of the room is not electrical shock proof not even the door.
- Water enters in the Transformer section due to the lower floor level during raining which is unexpected.
- Ear plugs are not used all time at VCB, Fabrication & Machine shop section.
- In powder coating section the powder sprayed manually and during this task no safety equipment is used. This is awfully unsafe & harmful work.

Undergraduate Internship Report

- Pretreatment system of powder coating is also unsafe. To overcome it, automatic or electrically controlled system and necessary safety should be introduced.
- In liquid paint section, blasting and painting is done manually almost without any safety equipments.
- In nickel coating section acid bath system is done without any safety equipments. These acts are very harmful for health. To overcome it, automatic or electrically controlled system and necessary safety equipments need to be used.

Energypac Engineering Ltd is alert for the safety of the workers and the factory. To ensure the safety they provide different safety elements for the workers. They also provide different heavy material handling equipments and some safety equipments for fire fighting. In this chapter all this safety system is briefly discussed. Even after that the workers need to be more concerned about the safety management system and their implementation.



Chapter 14

CONCLUSION

Energypac Engineering Ltd is one of the leading companies in the field of power sector in Bangladesh. They use different modern technologies for their production efficiencies. I have completed my industrial attachment at Energypac Engineering Ltd. In the report the whole production facilities observed by me during my industrial attachment is discussed.

14.1 Comments about the Factory

Energypac Engineering Limited plays an important role in power sector of Bangladesh by producing various electrical equipments. It can be more effective on economic development of the country by raising the production rate with better productivity. For this, the inventory system of this factory needs to be improved. Better production planning and forecasting is needed to be introduced. As a result the total loss will be reduced as well as the factory will earn more profit. To increase the overall production rate and productivity more number of machine, manpower, better layout and good understanding between the worker and owner should be maintained.

14.2 Conclusion

I am really happy to do the industrial attachment with the Energypac Engineering Limited. This is one of the supreme industries in power sector in Bangladesh, which supplies all kinds of electrical equipment used in substation and its manufacturing capacity is up to 75 MVA. Here in the report, all observation of mine during my industrial attachment at Energypac Engineering Ltd factory is discussed. At first chapter the company profile along with the scope and methodology of data collection for this report is discussed. The second chapter includes the total production system of power and distribution transformer. The third chapter is about the entire test done for the power and distribution transformer. The fourth chapter gives an idea about the production and assembling process of switchgear elements at the factory. The fifth chapter includes the production process and testing of different instrumental transformer. The sixth chapter is about

Undergraduate Internship Report

the isolator and breaker assembling and production process. In the seventh chapter the operations performed under the fabrication section is discussed. In the eighth, ninth and tenth chapter the procedure and manufacturing steps performed under the powder coating section, liquid paint section and nickel coating section is discussed. The working procedure and control system of CNC machine is discussed in the eleventh chapter. The twelve chapter incorporates the name and operations of the machine used under the machine shop. Chapter fourteen includes the safety management system and some findings about safety of Energypac. Energypac is an established company and has a good reputation. Here, Engineers play greatest contribution on the production. This attachment helps me to make a difference between theoretical and practical knowledge. Within the short time I have tried my best to acquire knowledge about the production system, production planning, safety management and inventory system of the factory. Both Engineer and Supervisor of all sectors in the factory were helpful to me. I hope that, the practical experience which I have gained from Energypac will be effective for my future job sector. I believe that my industrial attachment with Energypac is successful.

Reference

[1] www.energypac-bd.com

[2] Company Overview, <http://www.energypac-bd.com/company.php?id=34>

[2] Vision, Mission, Strategy, EnergyPac Ltd., <http://www.energypacbd.com/company.php?id=35>

