



**EAST WEST UNIVERSITY**

---

**Internship Report on**

Data Transmission

---

**Supervised By:**

Mr. Sarwar Jahan

Assistant Professor

ECE Department

---

**Submitted By**

Ahosan Hamid

ID: 2013-3-50-032

## **Declaration**

I, Ahsan Hamid, hereby declare that the presented report of internship titled “Transmission” of VOICETEL Ltd. is uniquely prepared by me after completion of three months work at Gulshan branch of VOICETEL Ltd.

I also confirm that, the report is only prepared for my academic requirement not for any other purpose. It might not be used with the interest of opposite party of the corporation.

---

Mr. Sarwar Jahan  
Assistant Professor  
ECE Department  
East West University

---

Dr. Mohammed Moseur Rahman  
Assistant Professor & Chairperson  
ECE Department  
East West University

---

Ahsan Hamid  
ID: 2013-3-50-032  
ECE Department  
East West University

## **Acknowledgement**

First of all ,I would like to express my gratitude to almighty Allah to enabling me to completion this report on "Transmission" successfully completion of any type of project requires helps from a member of persons .I have also taken help from different people for the preparation of this report. Now, there is a little effort to show my deep gratitude of the helpful person.

I convey my sincere gratitude to my Academic supervisor Mr. Sarwar Jahan Assistant Professor ECE Department, East West University .Without his kind direction and proper guidance this study would have been a little success. In every phase of the project this supervision and guidance shaped this report to be complete perfectly

I would like to also thank my colleagues of VOICETEL Ltd. to give a clear idea about transmission system in Bangladesh.

## **Abstract**

It was an extraordinary chance to work under VOICETEL Ltd. The fundamental reason for the program was to see the genuine circumstance. The scholarly learning isn't all around ok to rival genuine world. This temporary job program was useful to confront the genuine workplace. In VOICETEL Ltd. I have invested a decent energy in learning and was remunerated for my earnest attempts, figured out how to manage various circumstances, had understanding of corporate workplace which influences a representative execution and frame of mind towards work, had great time in learning and performing. I have likewise accumulated understanding about the choppiness of the inconvenience times while touchstone was experiencing one of its real progress stages. Certainty, on time basic leadership, consistency, diligent work, cooperation, searching accomplishment out of dim, development, authoritative survival are the key learning's out of my activity and I might want to state that it will be one of my best expertise that would stay with me and help me in future which will offer numerous difficulties.

# Contents

<b>1. Introduction</b>	1
<b>2. Organization Profile</b>	2
<b>3. Network Topology</b>	3 to 4
3.1 Constitution	3
3.2. Network topology	3
3.3. Interconnection Exchange (ICX)	4
<b>4. Transmission System</b>	6 to 29
4.1. Definition of transmission in all aspects	6
4.2. Types of transmission	7
4.2.1 Data transmission	7
4.2.1.1. Packet transmission	8
4.2.1.2. TDM Transmission	9
4.3. Capacity of Transmission	10
4.3.1. Features of STM-1	10
4.3.2. Features of STM-4	11
4.3.3. Features of STM-16	12
4.3.4. Features of STM-64	13
4.3.5 Bandwidth	13
4.4. Data Transmission and TDM Transmission	14
4.4.1. Physical Layer	14
4.4.2. Data Link Layer	15
4.4.3. Presentation layer	15
4.5. Technologies used in transmission	16
4.5. 1. PDH	16
4.5. 2. SDH	16
4.5.3. MPLS	17
4.5.4. Telecommuting	18
4.5.5. Computer-Supported Cooperative Work	18
4.5.6. Teleconferencing	19
4.5.7. Virtual private network	19
4.6. Interface	20
4.7. Transmission Media Types	21
4.7.1. Wired Transmission Media	21
4.7.1.1. Unshielded Twisted Pair wires	21
4.7.1.2. Coaxial Cable	22
4.7.1.3. Optical Fiber Cable	23
4.7.1.4. Wireless Transmission Media	24
4.7.1.5. Radio waves	24
4.7.1.6. Microwaves	25

4.7.1.7.3. Infrared-----	26
4.8. Topology of Transmission-----	26
4.9. MSP-----	27
4.10. Point of Interconnection (POI) -----	28
4.11. VOICETEL Ltd., has two POI-----	28
4.12. VOICETEL Switch Room-----	29
4.13. Point of Presence (POP) -----	30
<b>5. Office works-----</b>	<b>31 to 35</b>
5.1. Route analysis-----	31
5.2. Temperature Reading-----	32
5.3. IGW to ANS-----	33
5.4. Daily Domestic Traffic incoming-----	33
5.5. Daily Domestic Traffic out going-----	34
5.6. Consolation-----	35

# Section 1

## Introduction

The advancement of Bangladesh's media communications segment started with little strides in 1989 with the issuance of a permit to a private administrator for the arrangement of entomb alia cell versatile administrations to rival Bangladesh Telegraph and Telephone Board (BTTB), the past imposing business model supplier of broadcast communications benefits inside Bangladesh. Huge changes in the quantity of fixed and versatile administrations conveyed in Bangladesh happened in the late 1990s and the quantities of administrations in task have in this way developed exponentially in the previous five years.

Telecom controllers presented an ICX based interconnection system in 2007 and with that began another time of interconnection in Bangladesh. Examination of advantages of when the progressions have demonstrated that ICX based game plan can be helpful to the general interconnectivity situation. Specialist co-op everywhere throughout the world are currently underscoring on cost improvement and rearranged design which permits appropriation of future innovation/administrations. ICX based interconnection system can be the arrangement and the capability of such model is picking up in notoriety. Global Telecommunications Union (ITU's) ongoing distributions prescribe the idea of an "Interconnect Gateway Exchange" for the multi-administration and multi-administrator condition. The handbook recommends that nations setting up an 'Interconnect Gateway Exchange' in a multi-administrator condition can address the difficulties of multi-administrator and multi-administration interconnection condition all the more viably and proficiently.

## Section 2

### Organization Profile

Voicetel ICX is a telecommunications start-up, as Interconnection Exchange operator. Voicetel provide international and national voice call service SMS and VAS services

Voicetel is a part of Venture Project of Pertex Star Group, Karnaphuli Group and Metro Group. Mr M.A Hashem is its Honorary Advisor and Mr Saber Hossain Chowdhury M.P is its Chairman. Voicetel is operated with 5 working department, Core Network, Transmission Network, Billing Department, Accounts & Finance, and Corporate Relationship Department. Not only in Dhaka Voicetel is operated their business in Chittagong and Khulna too. Dhaka is the Head Quarter & Khulna Branch, whereas Chittagong zone is ruined by Combined ICX POI. As ICX (Interconnection Exchange) operating company Voicetel have to follow the international rule as the others countries exchange operator follows. VOICETEL LTD. was framed in the year 2011 by a devoted group of experts having wide involvement in the fields of Business and Product Development.

**Objectives:** The fundamental target of Voicetel Ltd. So to encourage telecommunications services to open proficiently by steering calls and interconnecting telecommunications organize in Bangladesh.

**Mission:** Building Infrastructure for Digital Bangladesh. So that the people of our country communicate with each other and abroad easily





## Section 3

### Network Architecture

#### 3.1 Constitution:

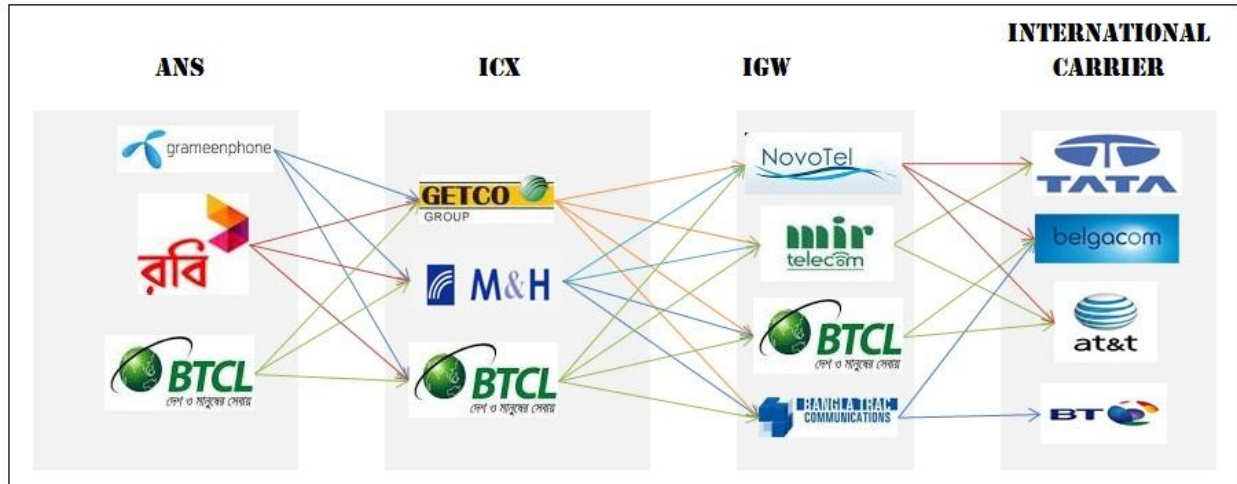

Figure 1: Basic network Structure of ICX, IGW and ANS of Bangladesh

As portray in the National Telecommunication Policy 1998 and global Long Distance Telecommunication Service (ILDTS) Policy 2007, each convenient manager is to interconnect through Interconnection Exchange (ICX) and overall calls to be dealt with by International Gateway (IGW) which is to be related with the adaptable and fixed chairmen through the ICXs.

The Interconnection Exchange (ICX) will get all calls from the adaptable and fixed directors at whatever point the call is made to other framework and will pass it to the objective organize if the call is neighborhood, and will go to the IGWs if the call is around the world. ICX will in like manner pass on calls got from IGWs where the call is foreordained.

### **3.2. Network topology:**

There are three layer of network architecture

1. The main layer is IGWs, which will be associated with International Long Distance Cable (ILDC) systems and ICX. Satellite earth station or VSAT is used to increase the signal in IGWs. But when ILDC (International Long Distance Cable) is available it didn't use satellite earth station or VSAT .
2. The next layer of network topology is the ICX, which will be in the middle of IGW and access system administration (ANS). IPTSPs will be associated with NIX for entomb IPTSP for residential voice traffic. Worldwide and entomb administrators residential voice traffic will be steered through ICXs.
3. The last Layer of network topology is the ANS administrators it gets benefits directly from the clients. In between the ICX/NIX the ANS the ANS ensure the accessibility. It means when there is no ANS the ICX/NIX remain ideal. This layer is to ensure the accessibility between the ICX/NIX and the supporters.

### **3.3. Interconnection Exchange (ICX):**

The Interconnection Exchange (ICX) will get all calls from the portable and fixed administrators at whatever point the call is made to other system and will pass it to the goal arrange if the call is neighborhood, and will go to the IGWs if the call is universal. ICX will likewise convey calls got from IGWs where the call is foreordained. The ICX has no endorser and isn't likewise straightforwardly associated with any abroad administrator. So the traffic of IGW's (International Gateway) and ANS's (Access Network Services) is likewise the traffic of ICX's.

1. Improve Quality of administration.
2. Ensure adjusted progression of Traffic among all administrators.
3. Keeping records of all calls along these lines encouraging GOVT to recognize and screen any calls.
4. Identifying, Monitoring and finding development of bastards/psychological militants.
5. Stopping tax evasion.
6. Help to decrease cell phone taking by actualizing IMEI.
7. Enable number immovability

Current Services:

1. Routing/exchanging entomb administrator residential calls.
2. Providing Roaming call offices.
3. Offering network framework among IGW, ICX, ANS Operators and IPTSP.
4. Routing/exchanging worldwide calls among ANS and IGW administrators.
5. Generating Call Detail Records (CDR) for BTRC.
6. Providing Data for National Monitoring Cell (NMC)

Future Services:

1. SMS, VMS or some other worth included administrations whenever required by ANS administrators.
  2. Bury zonal travel administrations subject to the endorsement of Commission.
  3. ENUM, IMEI and Number Portability benefits as and when coordinated by Commission.
- ICX administrator needs to introduce and keep up EIR administrations for the ANS work

# Section 4

## Transmission System

### 4.1. Definition of transmission in all aspects:

In broadcast communications, transmission is the way toward sending and spreading a simple or computerized data signal over a physical point-to-point or point-to-multipoint transmission medium, either wired, optical fiber or remote.

Transmission advancements and plans normally allude to physical layer convention obligations, for example, balance, demodulation, line coding, evening out, blunder control, bit synchronization and multiplexing, yet the term may likewise higher-layer convention obligations, for instance, digitizing a simple message sign, and information pressure.

One case of transmission is the sending of a sign with constrained length, for instance a square or parcel of information, a telephone call, or an email. Transmission of an advanced message, or of a digitized simple sign, is known as information transmission.

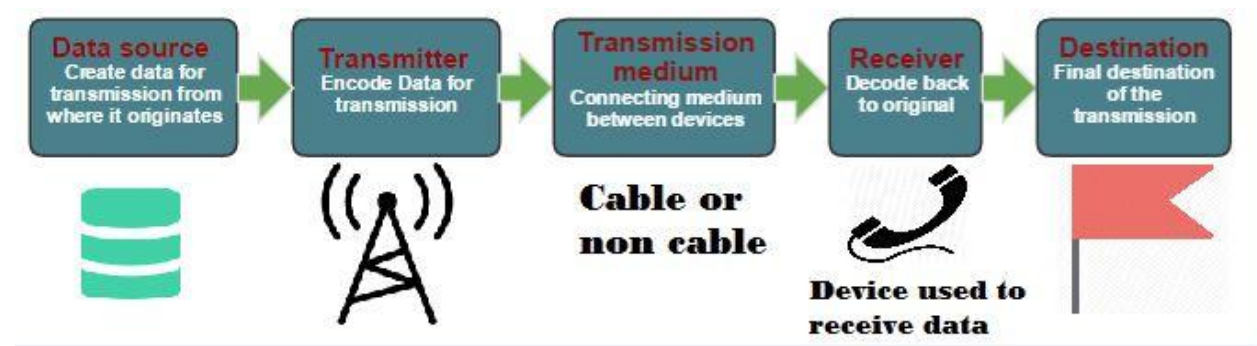

Figure 2: Basic Transmission System

## 4.2. Types of transmission

In electrical engineering, there are deals with two types of transmission:

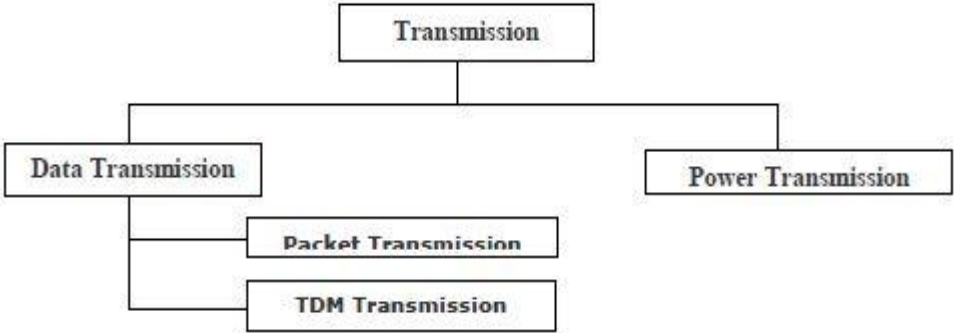

Figure 3: Transmission Type

### 4.2.1. Data transmission:

Information transmission additionally alluded to as computerized transmission, information move and advanced interchanges is the physical disregarding of information a correspondence channel. The correspondence channel could be remote, fiber or copper. Anyway we have to move our information, regardless of whether it be Ethernet utilizing machine conventions, for example, Fieldbus, Interbus, AS, CANopen, DeviceNet and Profibus or through USB, SMB or remote, Complete Electronics Ltd have both the link and associations required.

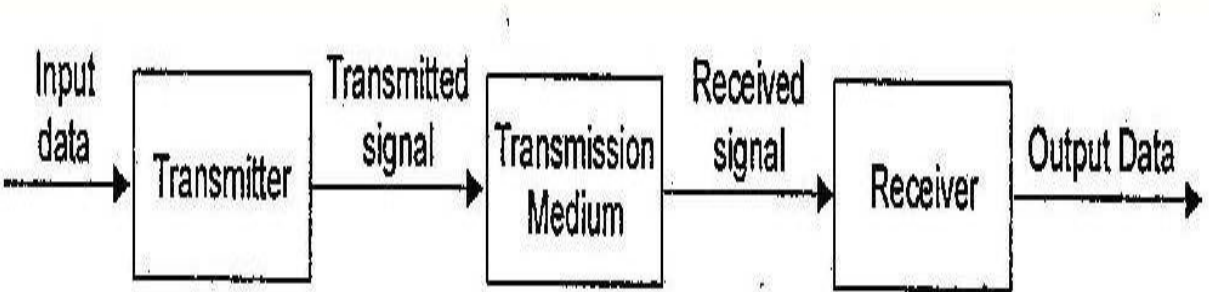

Figure 4: Data transmission system

### 4.2.1.1. Packet transmission

Information transmission term for a little heap of information sent over a system, (For example, a LAN or Internet). A bundle comprises of square of information bits in addition to control data those aides in its legitimate steering and reassembly into the first structure at the less than desirable end. Nobody size for parcels has been institutionalized and, contingent upon the convention of the system, it might likewise be known as a square, cell, or edge.

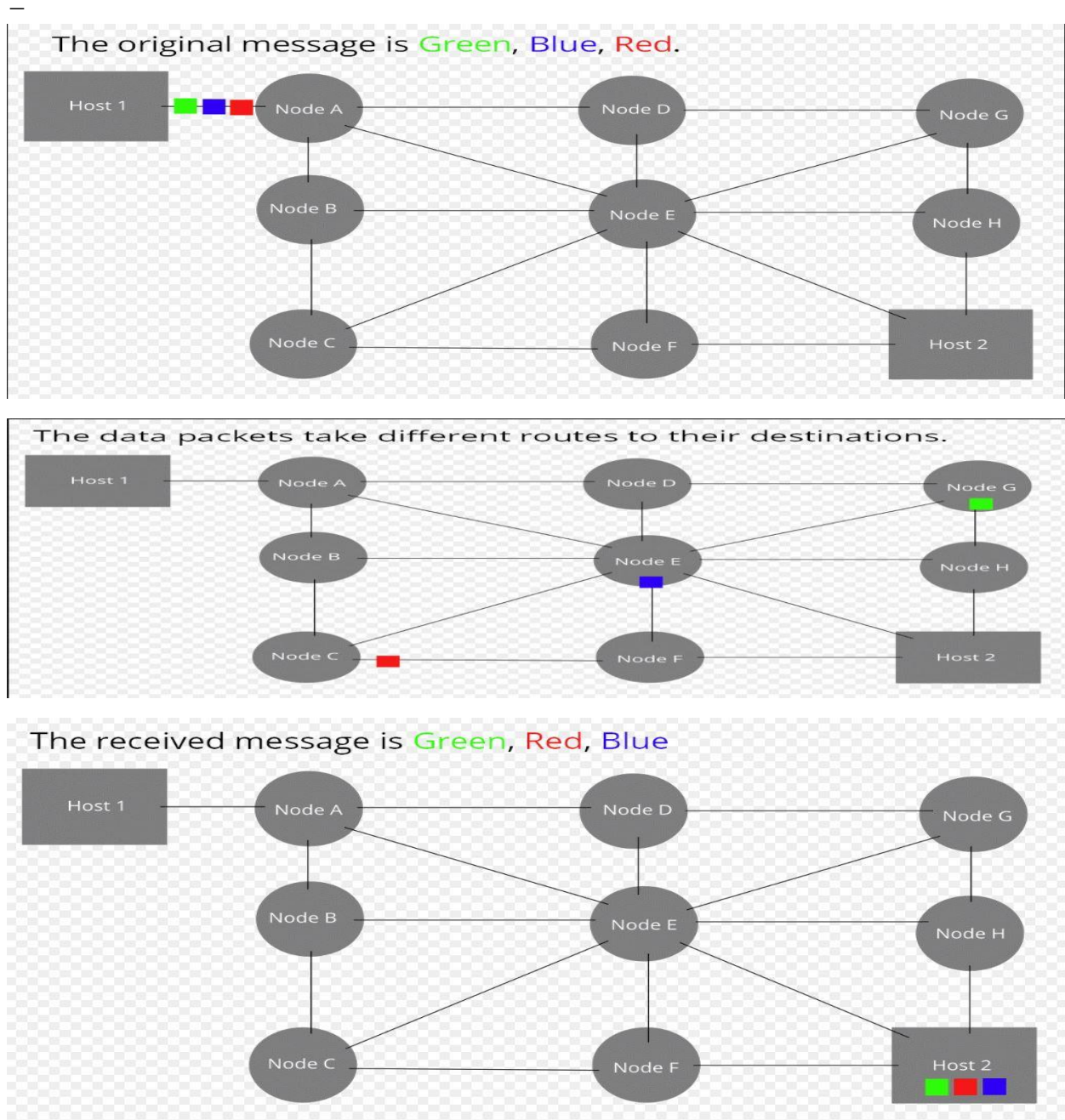

Figure 5: Packet transmission

#### 4.2.1.2. TDM Transmission:

Time division multiplexing is a method of transmitting and receiving the digital signal through a common path. In case in TDM the signal are divided in to small parts and sent over the channel. It is used when the bit pace of the transmission medium outperforms of the sign to be transmitted. Time-division multiplexing is utilized fundamentally for computerized signals, anyway may be associated in basic multiplexing in which in any event two banner or bit streams are moved appearing at the same time as sub-coordinates in a single correspondence channel, yet are physically substituting on the channel. The time space is isolated into a couple of availabilities of fixed length, one for each sub-channel.. A model byte or information square of sub-channel 1 is transmitted during timetable opening 1, sub-channel 2 during openness 2, and so forth. TDM can be categories in two major components TDM and synchronous time division multiplexing (sync TDM).In long-distance communication links TDM is useful and TDM can bears heavy data traffic loads. In time division multiple access (TDMA) TDM can also be used where stations sharing the same frequency channel who can communicate with one each other.

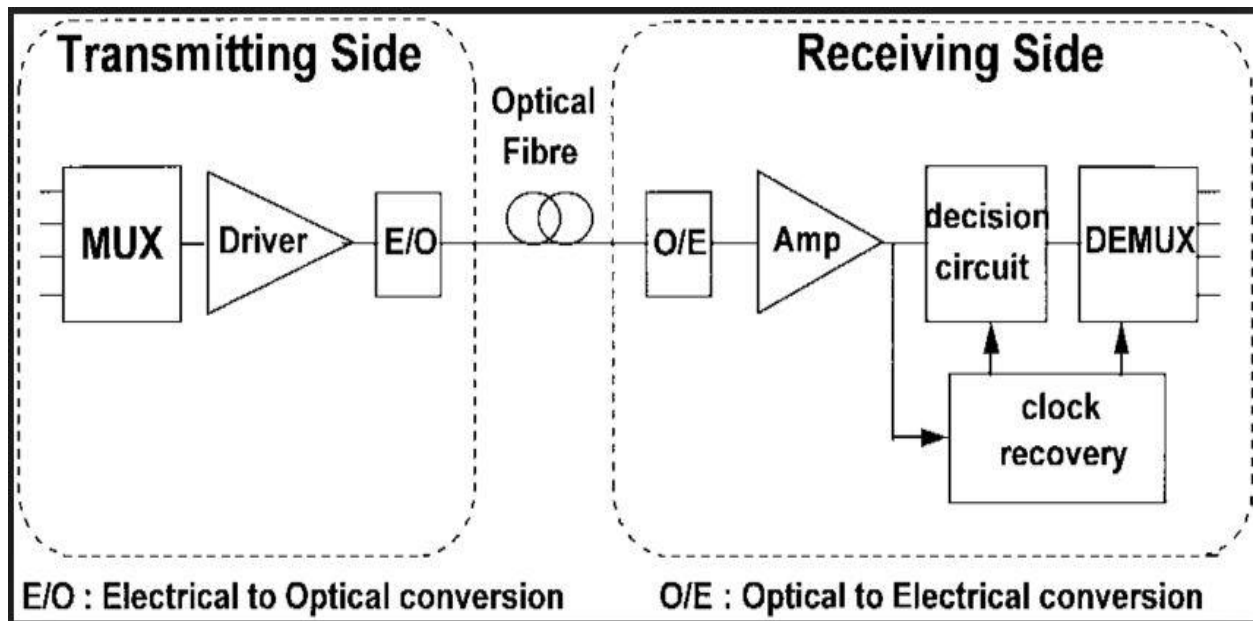

Figure 6: TDM Transmission

### 4.3. Capacity of Transmission:

Most extreme rate at which data can be transmitted over a correspondence way or channel is called channel limit. The principle highlight of a medium is its potential transmission speed, otherwise called channel limit, which for information transmission intentions is communicated in bits every second (bps). An elective proportion of transmission channel limit is transfer speed - the scope of sign frequencies that can be transmitted over the channel as far as possible depends upon four segments:

1. Information RATE (in bps)
2. Data transfer capacity (in Hz)
3. Clamor (in dB) 4. Mistake RATE (in %).

Bandwidth is corresponding to cost, for advanced information, it is attractive to get information rate as high as conceivable inside a farthest point of blunder rate for a given transmission capacity.

#### 4.3.1. Features of STM-1 :

The STM-1 (Synchronous Transport Module level-1) is the SDH ITU-T fiber optic network transmission standard. It has a bit rate of 155.52 Mbit/s.

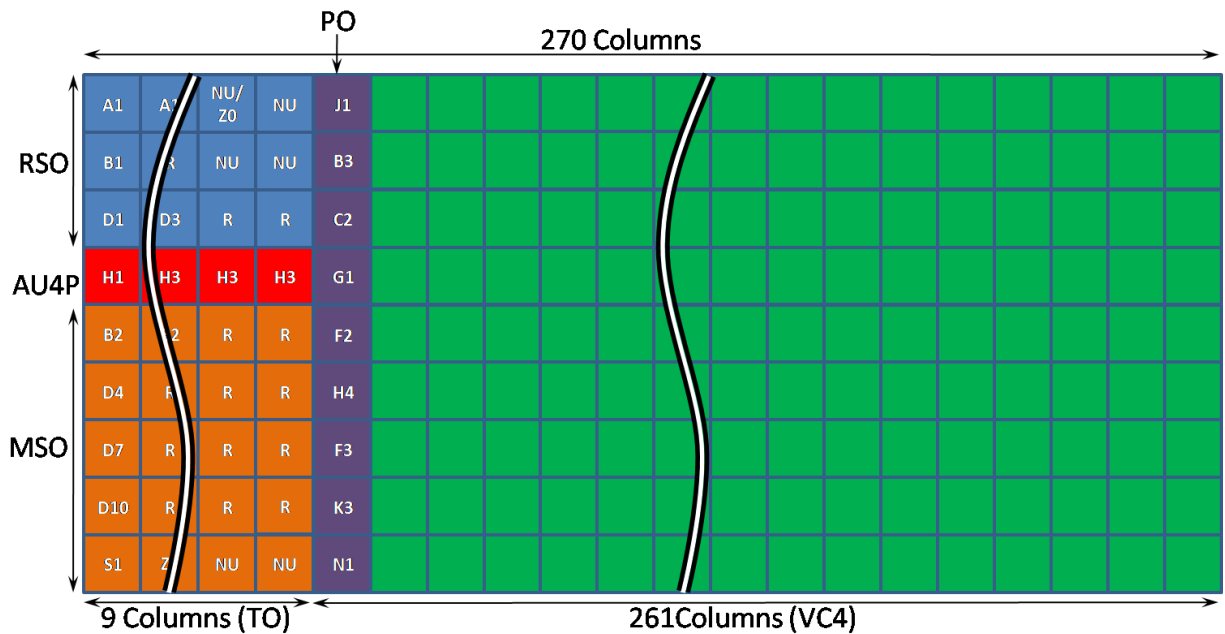

Figure 7: STM-1 frame structure



### Frame characteristic:

- 1) The STM-1 base frame is structured with the following characteristics:
- 2) Length:  $270 \text{ column} \times 9 \text{ row} = 2430 \text{ bytes}$
- 3) Byte:  $1\text{-byte} = 8 \text{ bit}$
- 4) Duration (Frame repetition time):  $125 \mu\text{s}$  i.e.  $8000 \text{ frame/s}$
- 5) Rate (Frame capacity):  $2430 \times 8 \times 8000 = 155.5200 \text{ Mbit/s}$
- 6) Payload =  $2349\text{bytes} \times 8\text{bits} \times 8000\text{frames/sec} = 150.336 \text{ Mbit/s}$

### 4.3.2. Features of STM-4

The VCL100 STM-1/4 is a secluded, and financially savvy STM-1/4 SDH multiplexer gear intended to oversee transmission capacity and voice and information access benefits over STM systems. The items are intended to help start to finish provisioning and the executives of administrations over all fragments of the optical system. It joins creative optical systems administration programming with the knowledge of SONET/SDH to convey an adaptable, practical system arrangement. The STM-4 (Synchronous Transport Module) is a SDH ITU-T fiber optic system transmission standard. It has a piece pace of  $622.080 \text{ Mbit/s}$ . This is called STM-4. The STM-4 particular is intended to convey  $7,680$  8-piece "voice" outlines each  $125$  miniaturized scale seconds for an all out payload bit pace of  $491.520 \text{ Mbit/s}$ .

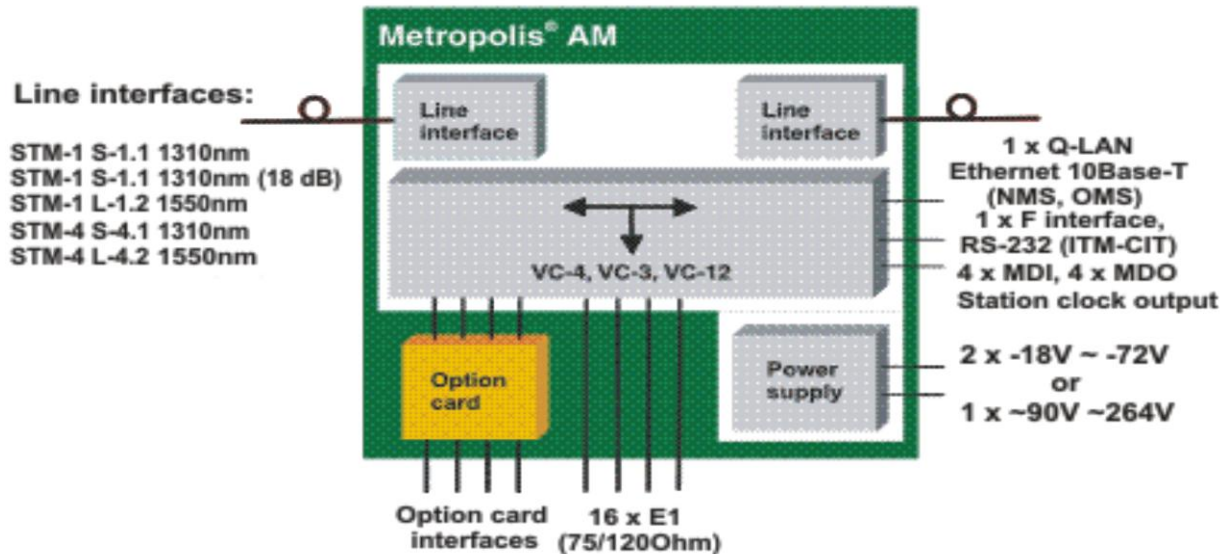

Figure 8: STM-4 frame structure

### Frame characteristic:

An STM-4 frame consists of 36 rows each containing 270 bytes. This is a direct multiple of STM-1, which consists of 9 rows each containing 270 bytes. The frame frequency of 32 kHz has also been chosen as a 4x multiple of that of STM-1, so that one byte of frame corresponds to the transmission capacity of a 64 kbit/s channel.

Operating Temperature: 0° to 50° C

Relative Humidity: 10% to 90%, non-condensing

### 4.3.3. Features of STM-16:

- 1) STM-16/64 SDH Multiplexer with MPLS-TP is a reduced POTP stage which is focused for sending in the edge and access some portion of a vehicle arrange.
- 2) It can be designed both as a TDM MSPP just as a Packet Switch.
- 3) It backings both TDM and Ethernet as Line Interfaces.
- 4) It offers full excess and accompanies a development frame for organization in high drop areas and can be utilized in point-to-point, straight, ring, T, and work systems.
- 5) Is a SDH ITU-T fiber optic system transmission standard.
- 6) It has the bit pace of 2,488.320 Mbit/s (~2.5 Gbit/s) .

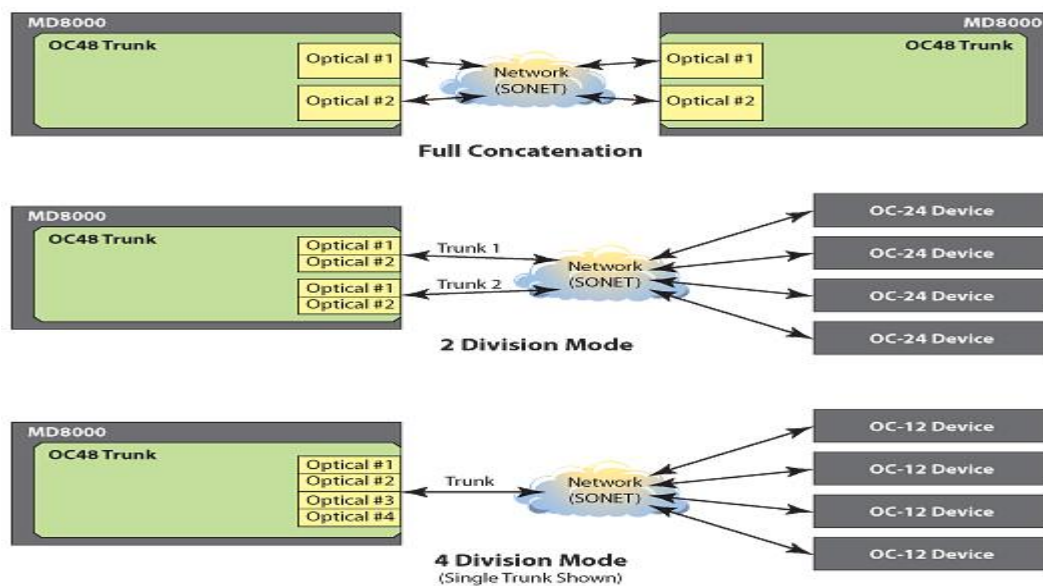

Figure 9: STM-16 frame structure

#### 4.3.4. Features of STM-64:

- 1) STM-16/64 SDH Multiplexer with MPLS-TP is a compact POTP platform which is targeted for deployment in the edge and access part of a transport network.
- 2) It can be configured both as a TDM MSPP as well as a Packet Switch.
- 3) It supports both TDM and Ethernet as Line Interfaces.
- 4) It offers full redundancy and comes with an expansion chassis for deployment in high drop locations and can be used in point-to-point, linear, ring, T, and mesh networks.
- 5) Is a SDH ITU-T fiber optic network transmission standard.
- 6) It has a bit rate of 9953.280 Mbit/s(~10Gbit/s)

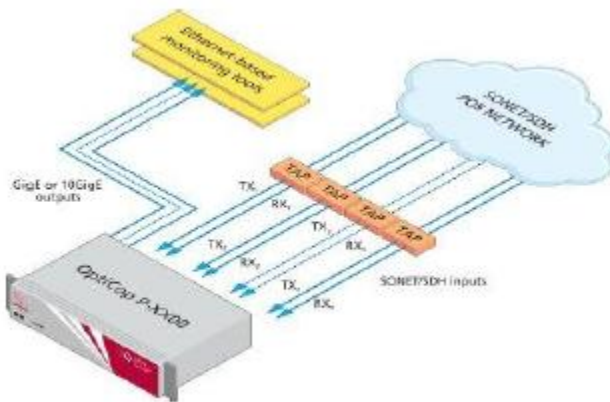

Figure 10: STM-64 frame structure

#### 4.3.5. Bandwidth:

##### 1 G bandwidth-

- 1) 1 G systems were developed in early 80's
- 2) The system was fully analog and used FDMA
- 3) 1G is designed for basic voice call

##### 2G bandwidth-

- 1) Start early 90's
- 2) The maximum data communication rate was 14.4 kbps
- 3) Data transfer speeds are typically low, around 9.6 Kbps

### **3G bandwidth-**

- 1) Frequency: 1.6 – 2.0 GHz
- 2) Bandwidth: 100MHz •
- 3) Characteristic: Digital broadband, increased speed
- 4) Technology: CDMA, UMTS, EDGE
- 5) Capacity (data rate): 144kbps – 2Mbps

### **4G bandwidth-**

- 1) Frequency: 2 – 8 GHz
- 2) Bandwidth: 100MHz
- 3) Characteristic: High speed, all IP
- 4) Technology: LTE, WiFi
- 5) Capacity (data rate): 100Mbps – 1Gbps
- 6) The bandwidth of 4G is 42 Mbps.

### **4.4. Data Transmission and TDM Transmission:**

There are three types of OSI layer used in data transmission

1. Physical Layer
2. Data-Link Layer
3. Presentation Layer

#### **4.4.1. Physical Layer:**

The physical layer or layer 1 is the first and most minimal layer of OSI model. Executed by a PHY chip. The physical layer characterizes the methods for transmitting crude bits. It changes over the advanced bits into electrical sign. The physical layer comprises of the electronic circuit transmission advances of a system.

Capacities and administrations performed by the physical layer are:

Giving institutionalized interface to a physical transmission medium, including. Determinations for IR over optical fiber or a remote IR correspondence connect. Mechanical detail of electrical connectors and links, for instance greatest link length. Bit-by-bit or image by-image conveyance. Radio interface, including electromagnetic range recurrence distribution and particular of sign quality, simple data transfer capacity, etc. Electrical determination of transmission line sign level and impedance.

#### **4.4.2. Information Link Layer:**

The information connection layer gives administration to the Network Layer above it:

1. The system layer is keen on getting messages to the relating system layer module on a nearby machine.
2. The remote Network Layer companion ought to get the indistinguishable message produced by the sender
3. The Network Layer needs to make certain that all messages it sends, will be conveyed effectively Note that subjective blunders may bring about the loss of the two information and control outlines.
4. The Network Layer needs messages to be conveyed to the remote companion in precisely the same request as they are sent.

#### **4.4.3. Presentation layer:**

The sixth layer of the OSI model is presentation layer the application layer get information from the presentation layer that's meaning the presentation layer delivery and formation information to the application layer. And the application layer use it for further processing .the architectures of each computer is different so it must use different data presentation .There are two types of OSI layer in TDM transmission:

- Data-Link Layer
- Physical Layer

##### **Data-Link Layer:**

1. Layer 2, the data-link layer, sends data frames from the network layer to the physical layer.
2. Error detection, correction.
3. Sharing a broadcast channel: multiple access protocols and LANs.
4. Link layer addressing.

##### **Physical Layer:**

1. Layer 1, the bottom layer of the OSI reference model, is the physical layer.
2. Physical Link transmitted data bits propagate across link.
3. Signals propagate in solid media e.g. copper, fiber.
4. Signals propagate freely, e.g. radio.

## 4.5. Technologies used in transmission:

There are different types technology used in transmission and they are-

### 4.5. 1. PDH

Plesiochronous Digital Hierarchy (PDH) was intended to ship the tremendous measures of information over advanced hardware like microwave radio or fiber optic frameworks. PDH bolsters an information transmission pace of 2048 Kbps. The information rate is constrained by a check in the gadget that produces the data.exact same request as they are sent.

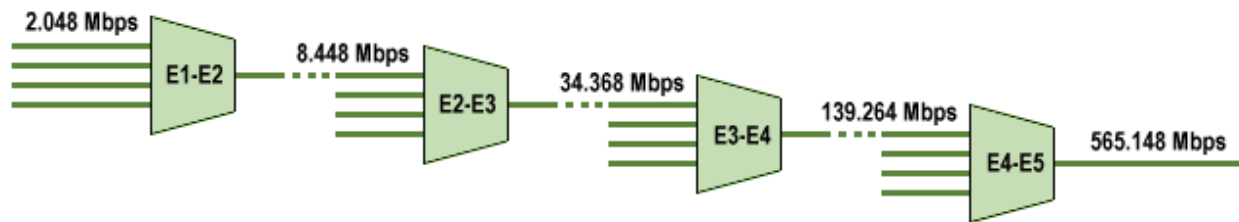

Figure 11: PDH data transport system

### 4.5.2. SDH:

The abbreviation SDH represents Synchronous Digital Hierarchy and alludes to a multiplex innovation utilized in broadcast communications. SDH permits information streams with low piece rates to be joined into high-rate information streams. Since the whole system is synchronous, singular piece streams can be installed into and removed from high-rate information streams generally effectively. SDH utilizes the accompanying Synchronous Transport Modules (STM) and rates: STM-1 (155 megabits for every second), STM-4 (622 Mbps), STM-16 (2.5 gigabits every second), and STM-64 (10 Gbps).

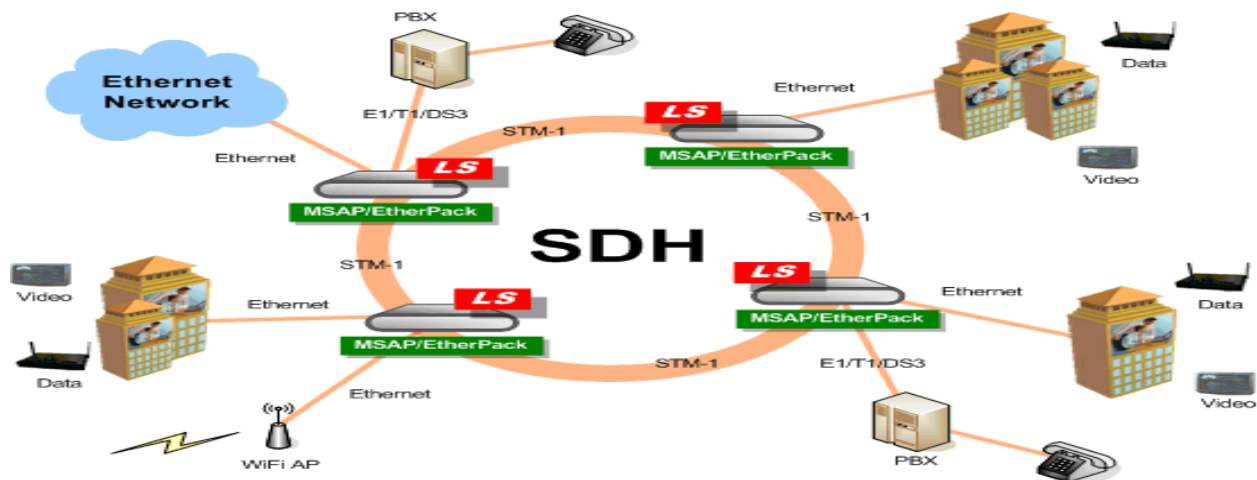

Figure 12: PDH data transport system

## SDH Signal----- STM-N Frame Structure:

The casing structure will guarantee that the low-rate tributary sign are dispensed as equitably and routinely in the edge as could be expected under the circumstances. Since this makes it simpler to actualize synchronous multiplexing, cross-association (DXC), include/drop, exchanging of tributaries. In a word this game plan encourages direct including/dropping of low-rate tributary sign to/from high-rate signals. In this manner, ITU-T characterizes the casing of STM-N as square shape square edges structure in unit of byte (8bit)

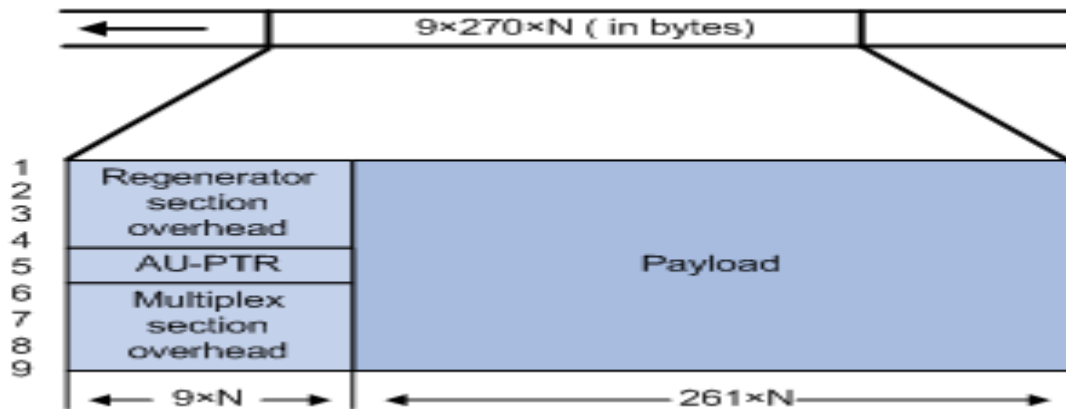

Figure 14: SDH Signal----- STM-N Frame Structure

### 4.5.3. MPLS:

One of data-carrying technique for high-performance telecommunications networks is Multiprotocol Label Switching (MPLS) it send data to the shortest path from one node to another node to avoid data complexity in case of speeding traffic flow and routing table. Packets are direct in MPLS network. And the data packet has a label in which they are assign and the labels are connected with a predetermine network path .Every switch in the system has a table demonstrating how to deal with parcels of a particular FEC type, so once the bundle has entered the system, switches don't have to perform header examination. Rather, consequent switches utilize the mark as a file into a table that furnishes them with another FEC for that parcel. This enables the MPLS system to deal with bundles with specific qualities in a steady manner. Parcels conveying continuous traffic, for example, voice or video, can without much of a stretch be mapped to low-dormancy courses over the system something that is trying with traditional steering.

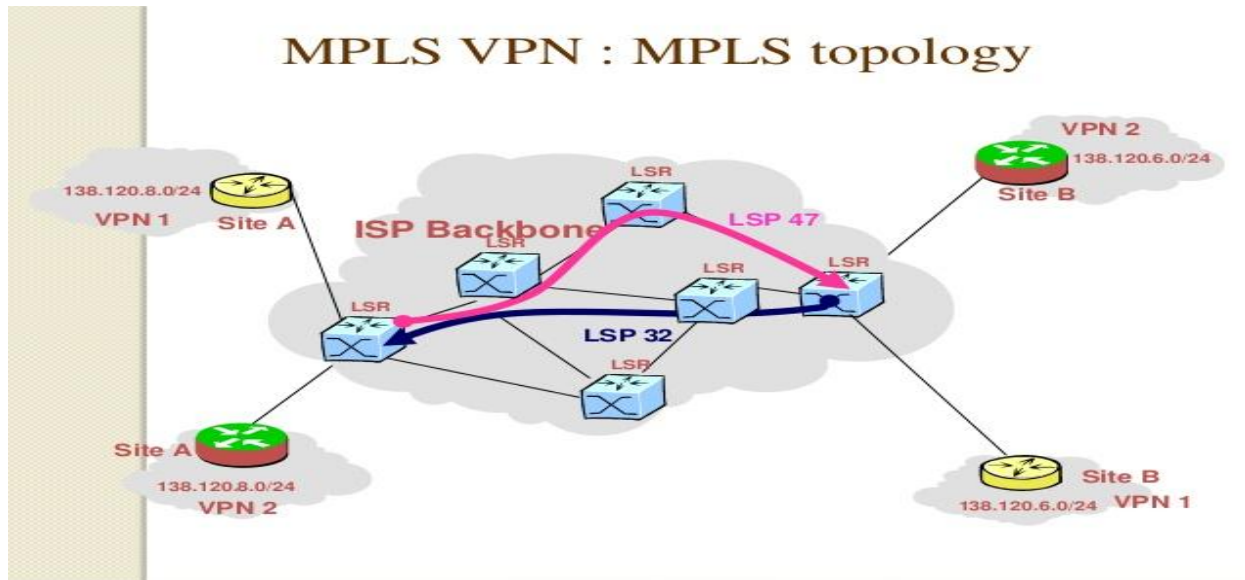

Figure 13: MPLS data transport system

#### 4.5.4. Telecommuting

Regardless of whether data innovation, for the most part, has yet had a huge. Effect on profitability in the work environment involves some discussion The image is obfuscated to a limited extent by (a) the trouble of estimating efficiency—particularly clerical efficiency—in totally unambiguous ways and (b) the way that data innovation, by goodness of its inescapability, has numerous aberrant impacts that are difficult to detach and follow

#### 4.5.5. Computer-Supported Cooperative Work:

With the assistance of PC systems, associates can coordinate a good ways off in manners that were unimaginable until reasonably as of late. Individuals in generally isolated areas can team up, for instance, progressively on composing a paper; every one of the creators can evaluate a similar draft and have the advantage of the considerable number of investigates when they are made. They can, basically, share the equivalent "composing surface" in spite of their geological detachment. System innovation can possibly present skill as a powerful influence for issues that are found somewhere other than where the master or specialists happen to be. A group of specialists, all situated at better places, may cooperatively address an issue requiring their aptitude. In principle, in any event, high-goals shows, combined with tele-administrator control innovation could make it feasible for a remotely found specialist not exclusively to offer guidance to on location staff yet even to perform working methods.



#### **4.5.6. Teleconferencing:**

Using system innovation to hold gatherings among "participants" situated in better places has been of enthusiasm since the mid 1960s (Bavelas et al., 1963). Regardless of this long-standing interest and in spite of the execution of a few test frameworks, video chatting has not yet turned out to be broadly utilized, notwithstanding when vis-à-vis gatherings include the cost and bother of significant travel

#### **4.5.7. Virtual private network:**

A virtual private system (VPN) broadens a private system over an open system, and empowers clients to send and get information crosswise over shared or open systems as though their registering gadgets were straightforwardly associated with the private system. Applications running on a figuring gadget, for example a workstation, work area, Smartphone, over a VPN may along these lines profit by the usefulness, security, and the executives of the private system. Encryption is a typical however not an intrinsic piece of a VPN association VPN systems may be classified by:

1. the tunneling protocol used to tunnel the traffic
2. the tunnel's termination point location, e.g., on the customer edge or network-provider edge
3. the type of topology of connections, such as site-to-site or network-to-network
4. the levels of security provided
5. the OSI layer they present to the connecting network, such as Layer 2 circuits or Layer 3 network connectivity
6. the number of simultaneous connections

#### **SDH Preferences over PDH**

SDH is really inferred from PDH, but makes parcels of changes on the premise of PDH. Compared with PDH, SDH includes a expansive number of preferences.

1. The standardized optical interfacing make it exceptionally helpful for interconnection in lines.
2. The world-standard outline structure and rate of digital signals make it simple to interconnect within the world.
3. SDH has amazing capacity of DXC.
4. SDH is prepared with the effective capacity of organizing and organize protection.
5. Synchronous structure is flexible.
6. SDH receives the synchronous mapping, embodiment and pointer to encourage the drop branches.
7. SDH is cost-effective and diminishes organizing fetched due to the transversal compatibility.
8. SDH has forward and in reverse compatibility.

## DH Impediments over PDH Though

SDH has bounty of points of interest compared with PDH, it still have a few impediments.

The shortcomings of SDH are as follows.

1. The utilization rate of SDH bandwidth is relatively low.
2. SDH is missing in organize security since of receiving the OAM as the checking and support instrument of its taking after exhibitions. As the common computer program, OAM is likely to be assaulted by infections or Trojans owing a few bugs of planning and creating it.

### **4.6. Interface:**

#### Electrical Interface:

Institutionalization of interfaces decides the probability of interconnection among various hardware from various merchants. SDH framework gives all inclusive models to arrange hub interfaces, including guidelines on advanced sign rate level, outline structure, multiplexing strategy, line interface, checking and the board, and so forth. So SDH gear of various sellers can be effectively interconnected, with the goal that hardware from various merchants can be introduced on a similar line, which completely shows the framework compatibility. SDH framework gives a lot of standard data structure levels, so a lot of standard rate levels. The fundamental sign transmission structure level is a synchronous vehicle module - STM-1 at a rate of 155 Mb/s. Advanced sign orders of higher levels, for example, 622 Mb/s and 2.5 Gb/s can be shaped by low-rate data modules through byte interleaved multiplexing. The quantity of modules to be multiplexed is a different of 4. For instance, STM-4=4xSTM-1 and STM-16=4xSTM-4.

#### Optical Interface:

Line interfaces receive all inclusive benchmarks. Line coding of SDH sign is just scrambling, rather than embeddings excess codes. The standard for scrambling is all inclusive. Hence the inverse terminal hardware jars be interconnected with SDH gear of various merchants by means of standard de-scrambler alone. The reason for scrambling is to make the likelihood of "1" bits and "0" bits event draws near to half to concentrate clock signals from line signals. As line sign are mixed just, the line sign paces of SDH are the equivalent with the standard sign paces of the SDH electrical interface. This won't add extra optical power punishment to the transmitting laser.

## **4.7. Transmission Media Types:**

Transmission media is two types

1. Wired Transmission Media
2. Wireless Transmission Media

### **4.7.1. Wired Transmission Media:**

Wired transmission media is media used to transfer information over a network, such as a twisted pair cable. There are various types of wired transmission media, including coaxial cables, telephone lines, and basically any information or data transmitted through a wire.

1. Unshielded Twisted Pair wires
2. Coaxial Cable
3. Optical Fiber

#### **4.7.1.1. Unshielded Twisted Pair wires**

This type of cable has the ability to block interference and does not depend on a physical shield for this purpose. It is used for telephonic applications.

Advantages:

1. Least expensive
2. Easy to install
3. High speed capacity

Disadvantages:

1. Susceptible to external interference
2. Lower capacity and performance in comparison to STP
3. Short distance transmission due to attenuation

#### 4.7.1.2. Coaxial Cable:

It has an external plastic covering containing 2 parallel conductors each having a different protected security spread. Coaxial link transmits data in two modes: Baseband mode (committed link transmission capacity) and Broadband mode (cable transfer speed is part into discrete extents). Link TVs and simple telecom companies broadly utilize coaxial links.

Advantages:

1. High Bandwidth
2. Better noise Immunity
3. Easy to install and expand
4. Inexpensive

Disadvantages:

1. Single cable failure can disrupt the entire network



Figure 13: Coaxial Cable

### 4.7.1.3. Optical Fiber Cable:

It uses the concept of reflection of light through a core made up of glass or plastic. The core is surrounded by a less dense glass or plastic covering called the cladding. It is used for transmission of large volumes of data.

Advantages:

2. Increased capacity and bandwidth
3. Light weight
4. Less signal attenuation
5. Immunity to electromagnetic interference
6. Resistance to corrosive materials

Disadvantages:

1. Difficult to install and maintain
2. High cost
3. Fragile
4. Unidirectional, i.e., will need another fiber, if we need bidirectional communication

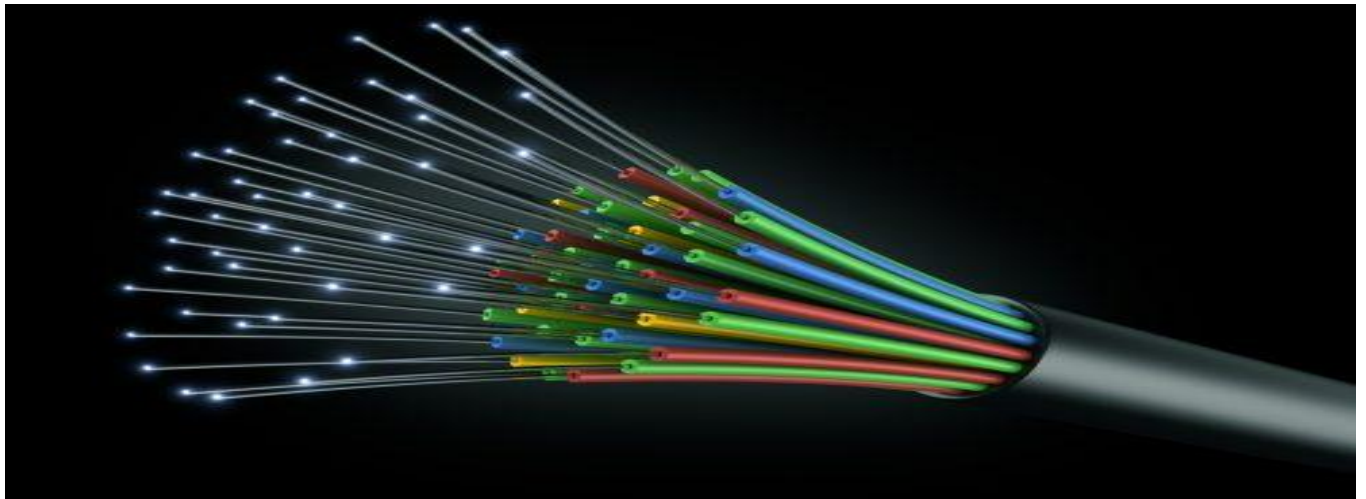

Figure 14: Optical Fiber Cable

#### **4.7.1.4. Wireless Transmission Media:**

- A remote transmission media uses radio waves and infrared light waves as a vehicle for their sign to have the option to move information, that way they won't be compelled to be choked by lines and will thusly have a bigger scope of buyers that they can support. Instances of remote transmission media are infrared, communicated radio,cellular radio, interchanges satellite, and a microwave. Remote transmission media empowers PCs to send information utilizing radio waves or infrared light. Infrared is a remote transmission medium that sends sign utilizing infrared light waves. Communicate radio is a remote transmission medium that appropriates radio flag through the air over long separations, for example, between urban areas, districts, and nations, and short separations, for example, inside an office or home. Cell radio is a type of communicated radio that is utilized broadly for versatile interchanges, explicitly remote modems and mobile phones. Microwaves are radio waves that give a fast signal transmission. An interchanges satellite is a space that gets microwave signals from an earth-based station, enhances the sign, and communicates the sign back over a wide region to any number of earth-based stations. Signal is broadcasted through air  
Features :
- Less Secure
- Used for larger distances

There are 3 major types of Wireless Transmission Media

#### **4.7.1.5. Radio waves:**

The radio wave is the basic of radio communications .it's like a waves on a lake, a radio wave could be a arrangement of rehashing peaks and valleys. The whole design of a wave, some time recently it rehashes itself, is called a cycle. The wavelength is the separate a wave takes to total one cycle. The number of cycles, or times that a wave rehashes in a moment, is called recurrence. Recurrence is measured within the unit hertz (Hz), alluding to a number of cycles per moment. One thousand hertz is alluded to as a kilohertz (KHz), 1 million hertz as a megahertz (MHz), and 1 billion hertz as a gigahertz (GHz). The run of the radio spectrum is considered to be 3 kilohertz up to 300 gigahertz. A radio wave is produced by a transmitter and after that recognized by a recipient. An receiving wire permits a radio transmitter to send vitality into space and a collector to choose up vitality from space. Transmitters and collectors are ordinarily planned to work over a restricted extend of frequencies.

Further Categorized as

- (i) Terrestrial and
- (ii) Satellite.



Figure 15: Radio waves:

#### 4.7.1.6. Microwaves:

It is a viewable pathway transmission for example the sending and accepting radio wires should be appropriately lined up with one another. The separation secured by the sign is legitimately corresponding to the stature of the radio wire. Recurrence Range: 1GHz – 300GHz. These are significantly utilized for cell phone correspondence and TV dissemination.

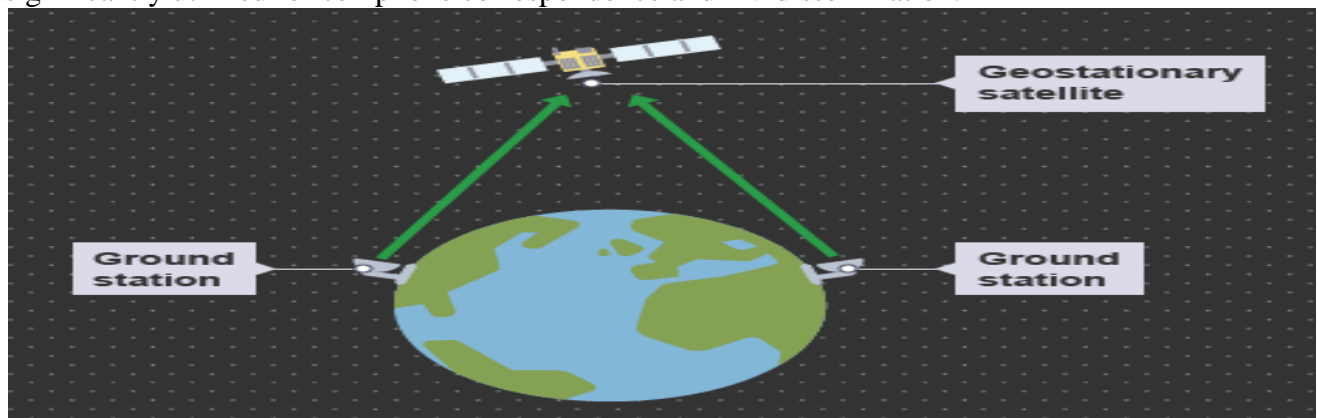

Figure 15: Microwave

### **4.7.1.7.3. Infrared:**

Infrared waves are utilized for exceptionally short separation correspondence. They can't enter through hindrances. This forestalls impedance between frameworks. Recurrence Range: 300GHz – 400THz. It is utilized in TV remotes, remote mouse, console, printer, and so on.

## **4.8. Topology of Transmission:**

### RING Topology

It is called ring topology since it frames a ring as every PC is associated with another PC, with the last one associated with the first. Precisely two neighbors for every gadget.

### Ring topology in computer networks

#### Features of Ring Topology

- 1.A number of repeaters are utilized for Ring topology with huge number of hubs, in such a case that somebody needs to send a few information to the last hub in the ring topology with 100 hubs, at that point the information should go through 99 hubs to arrive at the 100th hub. Thus to counteract information misfortune repeaters are utilized in the system.
- 2.The transmission is unidirectional, yet it very well may be made bidirectional by having 2 associations between each Network Node, it is called Dual Ring Topology.
- 3.In Dual Ring Topology, two ring systems are shaped, and information stream is inverse way in them. Additionally, on the off chance that one ring fizzles, the subsequent ring can go about as a reinforcement, to keep the system up.
- 4.Data is moved in a successive way that is a tiny bit at a time. Information transmitted, needs to go through every hub of the system, till the goal hub.

#### Advantages of Ring Topology

1. 1.Transmitting system isn't influenced by high traffic or by including more hubs, as just the hubs having tokens can transmit information.
2. 2.Cheap to introduce and grow

#### Disadvantages of Ring Topology

1. Troubleshooting is difficult in ring topology.
2. Adding or deleting the computers disturbs the network activity.



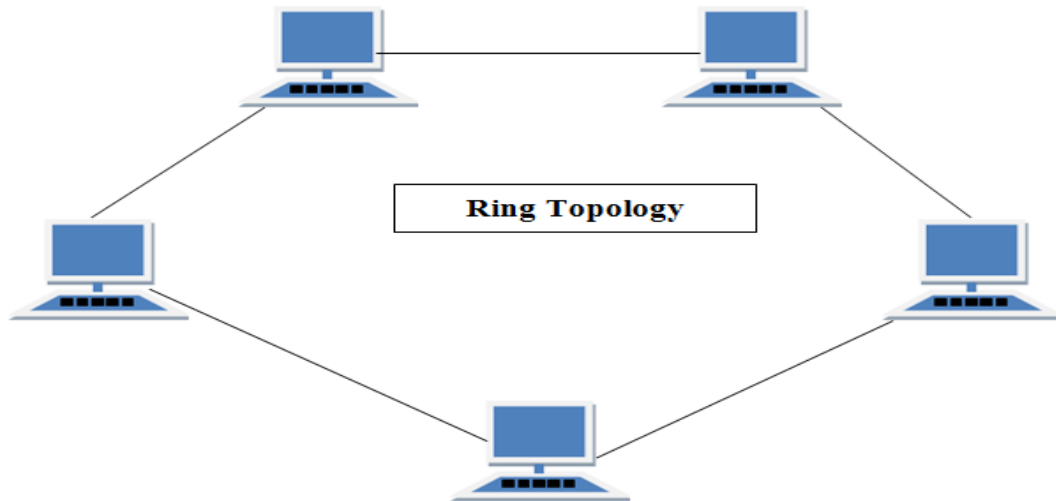

Figure 16: RING Topology

#### 4.9. MSP:

MSP-SNCP slightly described. MSP(Multiplex Section Protection) is a per span protection. A service line is protected using another line, called a protection line. If an error occurs, the protection mechanism should switch over to the protection line.

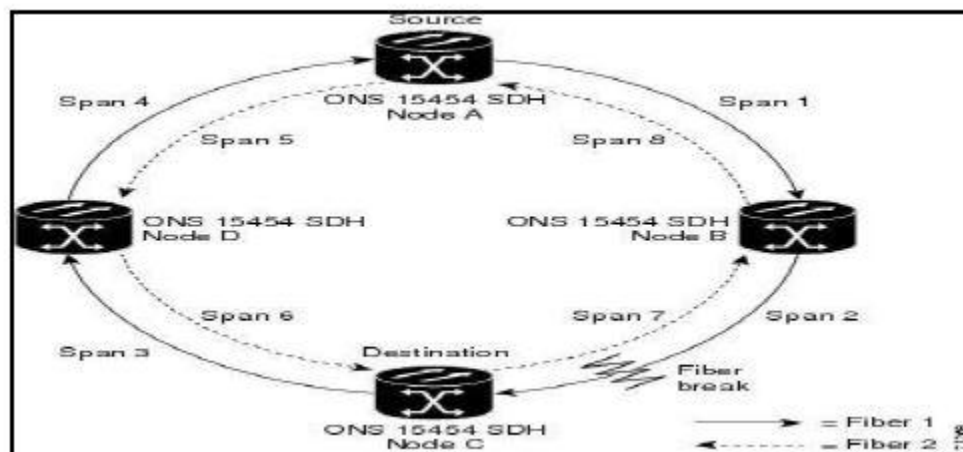

Figure 16: RING Topology

#### 4.10. Point of Interconnection (POI):

Point of Interconnection shall mean a physical location at which two or more networks interconnect through switches, nodes or other devices, offering access to operators or service providers.

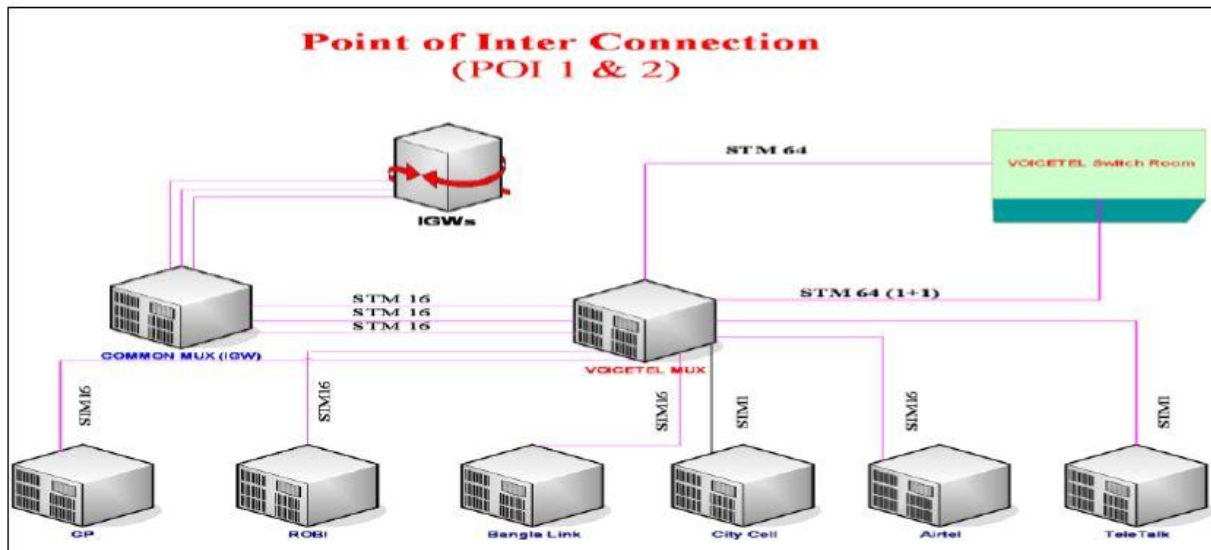

Figure 17: Point of Interconnection

#### 4.11. VOICETEL Ltd. has two POI:

POI (COLOASIA)  
POI (NRB)

1. All IGWs are connected with common IGW MUX.
2. In telecommunications and computer networks, multiplexing (sometimes contracted to muxing) is a method by which multiple analog message signals or digital data streams are combined into one signal over a shared medium.
3. The aim is to share an expensive resource. The multiplexed signal is transmitted over a communication channel, such as a cable.
4. The multiplexing divides the capacity of the communication channel into several logical channels, one for each message signal or data stream to be transferred. A reverse process, known as de-multiplexing, extracts the original channels on the receiver end. A device that performs the multiplexing is called a multiplexer (MUX), and a device that performs the reverse process is called a de-multiplexer (DEMUX or DMX).
5. IN POI (NRB), VOICETEL MUX (OSN 3500) is connected to the IGW's common MUX by two STM 16 link, connected to the VOICETEL Switch Room MUX (OSN 3500) by

two STM 64 link and connected to the ANS operators (like GP, BL, Robi, Citycell, Teletalk).

6. VOICETEL MUX (OSN 3500) is connected with Robi , GP, Banglalink, Airtel by STM 16 link and Citycell, Teletalk are connected with STM 1 link.
7. In POI (COLOASIA), VOICETEL MUX (OSN 2500) is connected to VOICETEL Switch Room MUX (OSN 3500) by two STM 16 link. One is redundant STM (MSP (1+1)). POI (OSN 2500) is a low capacity MUX. It provides only domestic calls to those operators which only want.

#### 4.12. VOICETEL Switch Room:

In VOICETEL Switch Room-

- POI is connected with VOICETEL Switch Room MUX (OSN 3500) by two

STM 64 link.

1. MUX is connected with UMG (Universal Media Gateway) by STM 1 links.
2. UMG is connected with Layer 3 Switch.
3. Layer 3 Switch is connected with NOC, Router and Soft Switch.
4. Soft Switch is connected with Billing Server.
5. Router is connected with two POPs by 2Mbps signaling links.

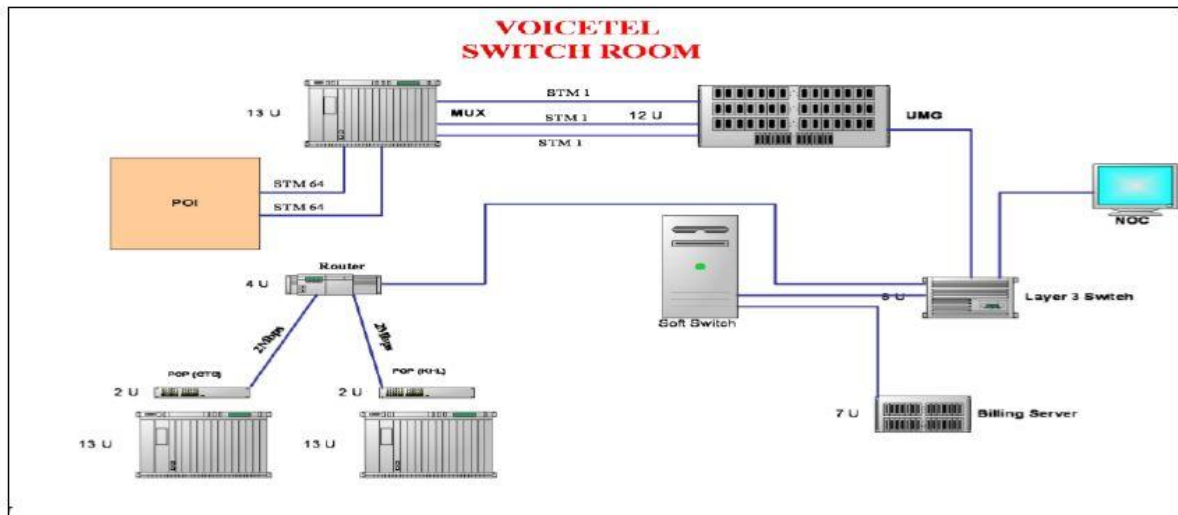

Figure 18: STM 64 link.

### 4.13. Point of Presence (POP):

“Point of Presence (PoP)” shall mean setting up of switching centre and transmission centre of appropriate capacity to provide on demand service of prescribed quality and grade of service in a non-discriminatory manner.

1. VOICETEL is connected with two POP:
2. In case of Chittagong-
3. VOICETEL Switch Room (Dhaka) is connected with Switch (S9303).
4. The Switch is connected with MUX (OSN 2500) and UMG (8900).
5. UMG (8900) is connected with MUX (2500) by many STM 1 link.
6. The MUX is then connected with all available operators (GP, BL, ROBI, TELETALK, CITYCELL, AIRTEL).
7. TELETALK, CITYCELL, AIRTEL).

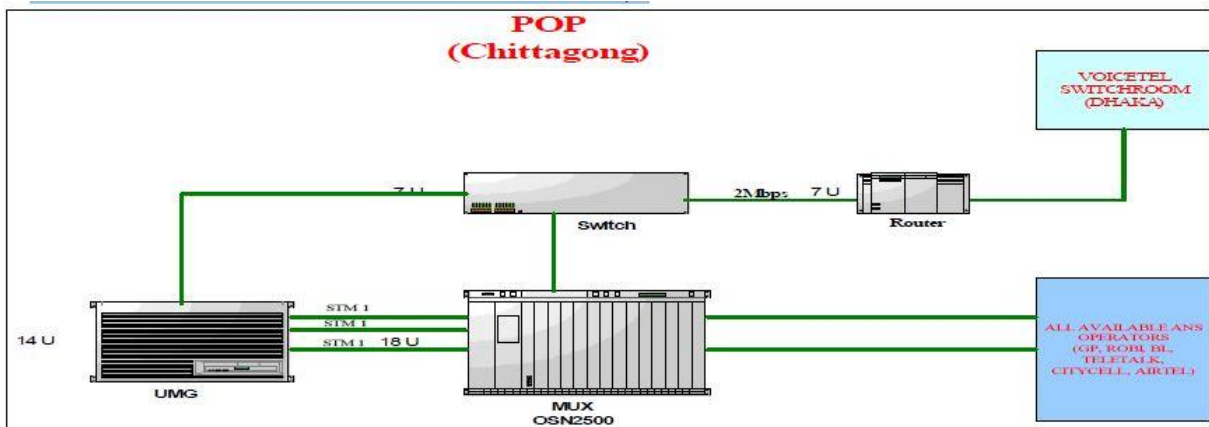

Figure 19: Point of Presence (Chittagong)

### In case of Khulna-

1. VOICETEL Switch Room (Dhaka) is connected with Switch (S9303).
2. The Switch is connected with MUX (OSN 1500) and UMG (8900).
3. UMG (8900) is connected with MUX (1500) by many STM 1 link.
4. The MUX is then connected with all available operators (GP, BL, ROBI, TELETALK, AIRTEL).
5. TELETALK, AIRTEL).

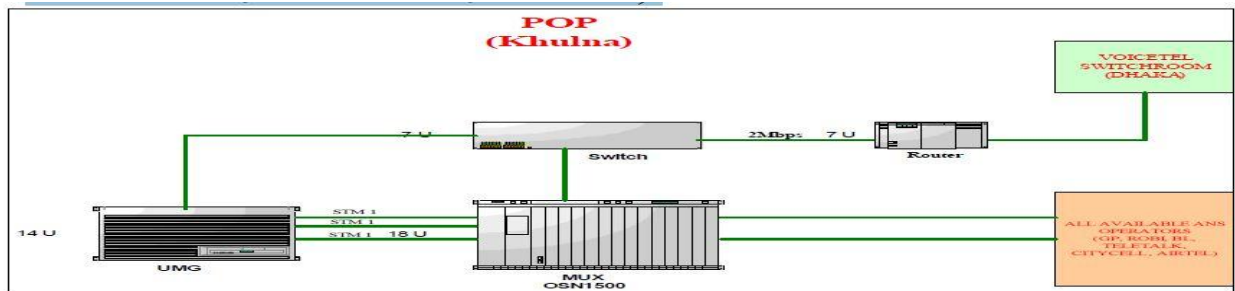

Figure 20: Point of Presence (Khulna)

# Section 5

## Office works

### 5.1. Route analysis:

TOP-30-Route Analysis.xlsm - Microsoft Excel

Date: 2019-08-25 00:30

**PREFIX WISE ROUTE ANALYSIS-TOP-30-DEST.**

Country Name	Country Prefix	BTRAC (12)				ROOTS (19)				UNIQUE (21)				Global Voice(16)				MIR (13)				NOVQ(15)				DIGICON(37)					
		Attem pt	CER	ASR	ACD	Attem pt	CER	ASR	ACD	Attem pt	CER	ASR	ACD	Attem pt	CER	ASR	ACD	Attem pt	CER	ASR	ACD	Attem pt	CER	ASR	ACD	Attem pt	CER	ASR			
Others	00	0	0%	0%	0	0	0%	0%	0	4	75%	25%	26	0	0%	0%	0	0	0%	0%	0	0%	0%	0	2	100%	0%	0	0	0%	0%
United States	001	0	0%	0%	0	0	0%	0%	0	37	92%	43%	76	0	0%	0%	0	14	86%	36%	60	0	0%	0%	0	0	0%	0	0	0%	
South Africa	0027	0	0%	0%	0	0	0%	0%	0	0	0%	0%	0	0	0%	0%	0	4	100%	25%	2	0	0%	0%	0	0	0%	0	0	0%	
France	0033	0	0%	0%	0	0	0%	0%	0	0	0%	0%	0	0	0%	0%	0	0	0%	0%	0	0	0%	0	2	100%	0%	0	0	0%	
Italy	0039	0	0%	0%	0	0	0%	0%	0	0	0%	0%	0	0	0%	0%	0	0	0%	0%	0	0	0%	0	0	0%	0	21	100%	0%	
Great Britain	0044	3	100%	67%	3	0	0%	0%	0	0	0%	0%	0	0	0%	0%	0	0	0%	0%	0	0	0%	0	0	0%	0	29	97%	17%	
Malaysia	0060	0	0%	0%	0	95	97%	18%	77	0	0%	0%	0	0	0%	0%	0	0	0%	0%	0	0	0%	0	0	0%	0	0	0%	0%	
Australia	0061	0	0%	0%	0	0	0%	0%	0	0	0%	0%	0	0	0%	0%	0	0	0%	0%	0	0	0%	0	0	0%	0	4	75%	0%	
Singapore	0065	0	0%	0%	0	0	0%	0%	0	17	94%	6%	8	0	0%	0%	0	0	0%	0%	0	0	0%	0	0	0%	0	0	0%	0%	
Thailand	0066	0	0%	0%	0	0	0%	0%	0	1	100%	0%	0	0	0%	0%	0	0	0%	0%	0	0	0%	0	0	0%	0	0	0%	0%	
South Korea	0082	0	0%	0%	0	0	0%	0%	0	2	100%	0%	0	0	0%	0%	0	0	0%	0%	0	0	0%	0	1	100%	0%	0	0	0%	
China	0086	0	0%	0%	0	1	100%	100%	13	0	0%	0%	0	0	0%	0%	0	0	0%	0%	0	0	0%	0	0	0%	0	0	0%	0%	
India	0091	0	0%	0%	0	26	100%	4%	75	0	0%	0%	0	45	91%	7%	178	0	0%	0%	0	12	100%	0%	0	18	100%	17%			
Pakistan	0092	0	0%	0%	0	0	0%	0%	0	0	0%	0%	0	0	0%	0%	0	0	0%	0%	0	0	0%	0	3	100%	0%	0	0	0%	
Libya	00218	0	0%	0%	0	0	0%	0%	0	0	0%	0%	0	0	0%	0%	0	0	0%	0%	0	0	0%	0	0	0%	0	3	100%	33%	
Lebanon	00961	0	0%	0%	0	0	0%	0%	0	0	0%	0%	0	0	0%	0%	0	0	0%	0%	0	0	0%	0	0	0%	0	8	88%	13%	
Jordan	00962	7	100%	71%	6	0	0%	0%	0	0	0%	0%	0	0	0%	0%	0	0	0%	0%	0	0	0%	0	0	0%	0	0	0%	0%	
Iraq	00964	2	100%	0%	0	0	0%	0%	0	0	0%	0%	0	0	0%	0%	0	0	0%	0%	0	0	0%	0	0	0%	0	0	0%	0%	
Kuwait	00965	0	0%	0%	0	0	0%	0%	0	0	0%	0%	0	0	0%	0%	0	0	0%	0%	0	0	0%	0	0	0%	0	0	0%	0%	

Figure 21: Top 30 Route analyses

CER: Amount of call reached destination successfully  
 ASR: Amount of call being answered  
 ACD: Amount of call successfully stayed

## 5.2. Temperature Reading:

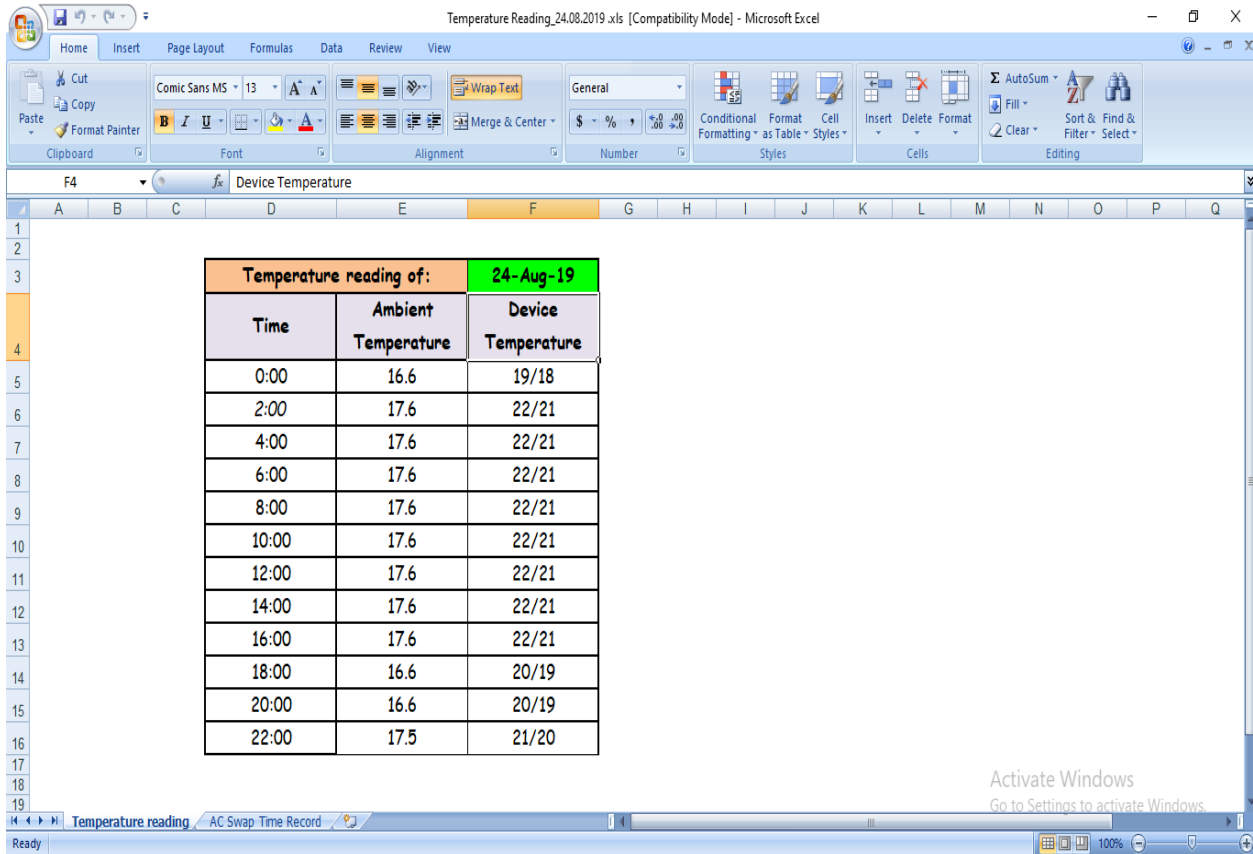

Figure 22: Temperature Reading

Ambient temperature: Ambient temperature means room temperature which is rated by machine

Device temperature: Device temperature which is rated software

### 5.3. IGW to ANS:

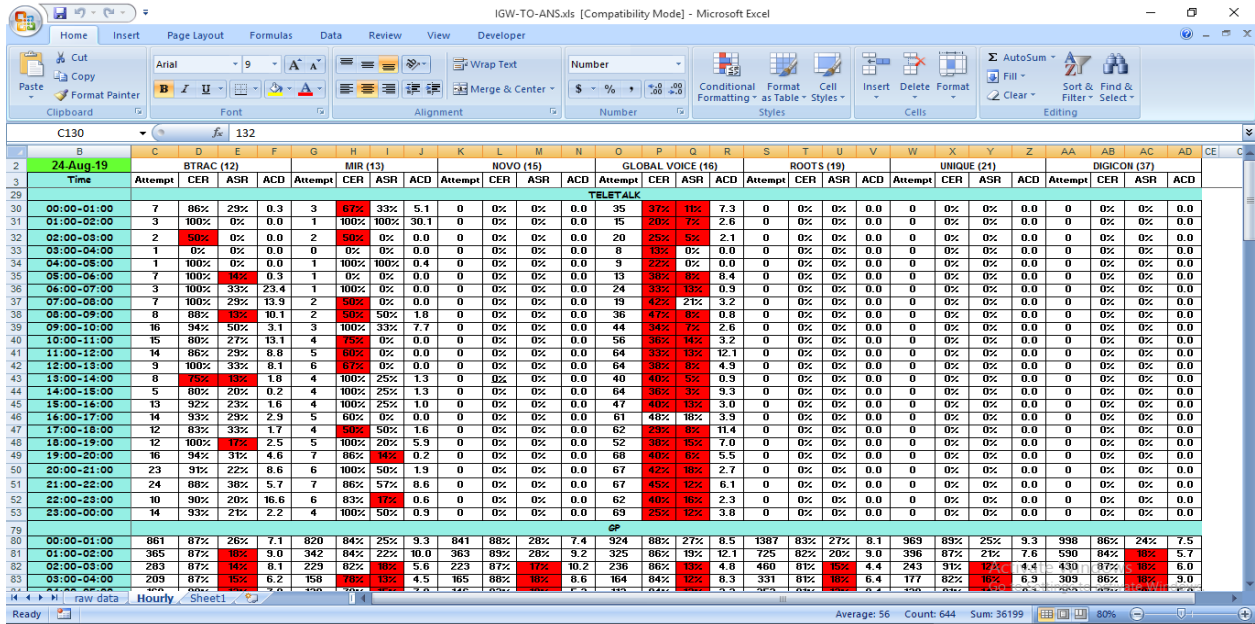

Figure 23: IGW to ANs

### 5.4. Daily Domestic Traffic incoming:

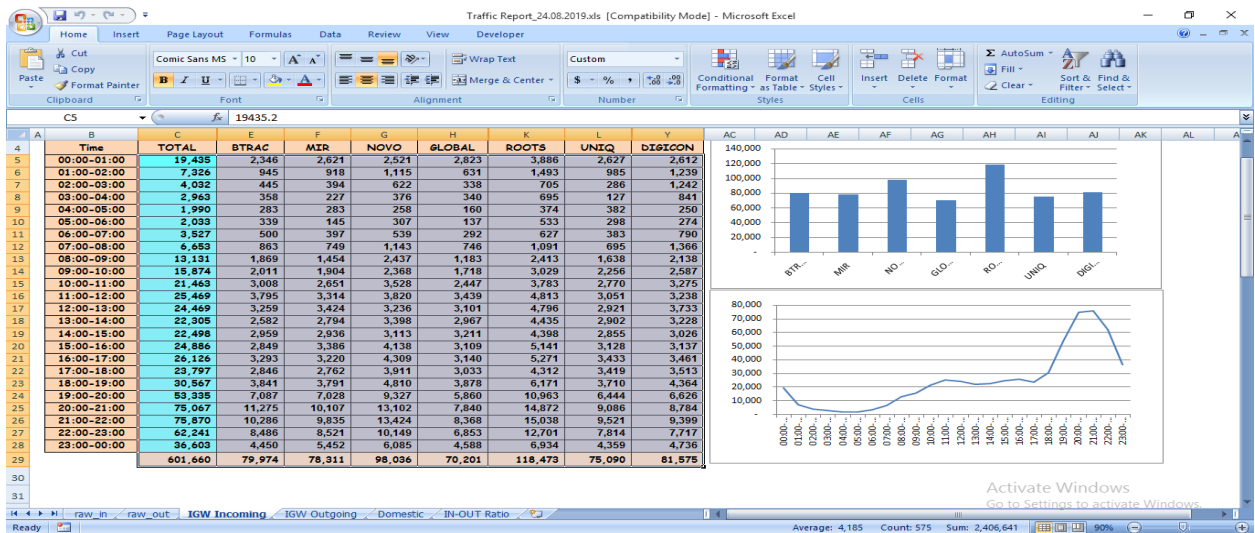

Figure 24: Daily Domestic Traffic incoming

## 5.5. Daily Domestic Traffic out going:

				Date & Time		25-Aug-2019 00:00
Rtn	IGW	CER	ASR	ACD	Last Hour Minute	Total Minute
12	BTRAC	94%	40%	11	108	1,645
13	MIR	85%	12%	75	95	1,373
15	NOVO	94%	42%	10	32	898
16	GLOBAL VOICE	91%	11%	99	64	1,205
19	ROOTS	91%	16%	21	63	2,160
21	UNIQUE	91%	23%	44	112	1,330
37	DIGICON	95%	12%	46	52	1,073
						9,685

Figure 25: Daily Domestic Traffic out going

Last hour minute: Total talking minute in last 1 hour for each IGW

Total Minute: Total talking time in last 24 hour



## 5.6. Consolation:

In review this internship has been an excellent and rewarding experience I have had the option to meet and system with such huge numbers of individuals that I am certain will most likely assist me with circumstances later on. One primary concern that I have learned through this temporary position is time the executives aptitudes just as self-inspiration. When I initially began I didn't believe that I would have been ready to cause myself to sit in an office for six hours every day, four days per week. When I understood what I needed to do I composed my day and work so I was not covering or squandering my hours. I discovered that I should have been sorted out and have questions prepared for when it was the right time to get criticism. From this entry level position and time the executives I needed to figure out how to persuade myself through being in the workplace for such a large number of hours. I came up with various proposals and ideas that the company is still looking into using.

## Reference:

1. <http://searchtelecom.techtarget.com/definition/dense-wavelength-division-multiplexing>
2. [https://en.wikipedia.org/wiki/Data\\_transmission](https://en.wikipedia.org/wiki/Data_transmission)
3. <http://searchnetworking.techtarget.com/definition/SDH>
4. <http://searchtelecom.techtarget.com/definition/dense-wavelength-division-multiplexing>
5. <http://searchmobilecomputing.techtarget.com/definition/W-CDMA>
6. <https://www.onlinelms.org/mod/book/view.php?id=43&chapterid=454>
7. <https://www.studytonight.com/computer-networks/network-topology-types>
8. <https://www.slideshare.net/hemantchetwani/channel-capacity-and-transmission-media>
9. <https://www.techopedia.com/definition/9669/time-division-multiplexing-tdm>
10. [https://media.ciena.com/documents/TN-4T\\_STM-4\\_Terminal\\_Multiplexer\\_DS.pdf](https://media.ciena.com/documents/TN-4T_STM-4_Terminal_Multiplexer_DS.pdf)
11. [https://its-wiki.no/images/c/c8/From\\_1G\\_to\\_5G\\_Simon.pdf](https://its-wiki.no/images/c/c8/From_1G_to_5G_Simon.pdf)
12. <https://en.wikipedia.org/wiki/STM-4>